



LMI[®]



LIQUITRON™

DP5000 Series pH Controller

Instruction Manual

Manual No : 1756

Rev. : J

Rev. Date : 5/2019



LMI[®]



TABLE OF CONTENTS

1.0 INTRODUCTION	1
2.0 UNPACKING	2
3.0 INSTALLATION	3
3.1 PRE-INSTALLATION	3
3.2 ENVIRONMENT	3
3.3 INSTALLATION	3
3.4 MOUNTING THE ELECTRONIC ENCLOSURE	3
3.5 ELECTRICAL INSTALLATION	5
3.5.1 Electrical Connections	5
3.5.2 Terminal Board Signal Description	8
3.5.3 Field Wiring Instructions	9
3.6 pH ADJUSTMENT PUMP(S)	10
3.7 KEYPAD AND DISPLAY	10
4.0 OPERATION	12
4.1 DEFAULT SETTINGS	12
4.1.1 Proportional Mode	13
4.1.2 ON / OFF Mode	14
4.2 ALARMS	16
4.3 CALIBRATION (VIEWING LAST CALIBRATION DATA)	17
4.4 NEW CALIBRATION	17
4.5 PUMP TIMERS AND SOLENOID VALVE CONTROL TIMERS	19
4.5.1 Pump Run Time	19
4.5.2 Solenoid Delay Pump Valve Time	19
4.5.3 Setting Timers	20
4.5.4 Solenoid Valve Control	20
4.5.5 Display Key	21
4.6 ADVANCED MENU	22
5.0 MAINTENANCE	23
5.1 pH ELECTRODE AND CABLE	23
6.0 TROUBLESHOOTING	24
6.1 ERROR MESSAGES	24
7.0 DP5000 SPECIFICATIONS	25
8.0 PROGRAM LOG	27
9.0 PARTS LIST	28
10.0 EXPLODED VIEW	29

LIST OF ILLUSTRATIONS

FIGURE 1. Unpacking Items 2

FIGURE 2. Minimum Clearances 3

FIGURE 3A. Typical In-Line Installation 4

FIGURE 3B. Typical Batch Installation 4

FIGURE 4. Electrode and Pump Connections 6

FIGURE 5. Terminal Strip 7

FIGURE 6. Circuit Board. 9

FIGURE 7. Keypad 10

FIGURE 8. ON / OFF Control 12

FIGURE 9. Proportional 12

FIGURE 10. Pump A Control Profile 13

The LIQUITRON™ DP5000 Series pH Controllers are designed for a variety of industrial pH applications including metal finishing, water treatment, printed circuit board manufacturing and waste treatment.

The LIQUITRON™ DP5000 is a microprocessor-based pH controller with a backlit customized display and tactile keypad for ease of programming. The DP5000 allows independent programming of control methods ('ON / OFF' or 'PROPORTIONAL') for acid (Pump A) or base (Pump B) dosage. Independent high and low pH alarms may be set with activation of the 'Alarm relays.' A third relay output is available for activating a solenoid valve or other devices.

The controller is compatible with any pH electrode that generates a mV signal and allows incorporation of platinum 1000 W automatic temperature compensation (ATC) elements. Two point or single point pH calibrations may be performed. Timer functions for pump 'Run' time and solenoid 'Delay' times can be programmed to operate a solenoid pump valve. An 'Advanced Menu' allows selection of special features such as a 'Point 3' (inflection point) for the control profiles of the acid or alkali pumps for finer control. The DP5000 features continuous non-volatile memory back-up, voltage selection, pre-amplifier outputs, flow and level switch inputs as standard. 4-20 mA recorder output is optional.

SECTION 2 - UNPACKING

Your carton will contain the items shown in *Figure 1*. Please notify the carrier immediately if there are any signs of damage to the controller or its parts. Contact your LMI® Distributor if any of the parts are missing.

There is a number label on the inside cover of the unit; for easy reference, you should note the model and serial numbers on the front cover of this instruction manual.

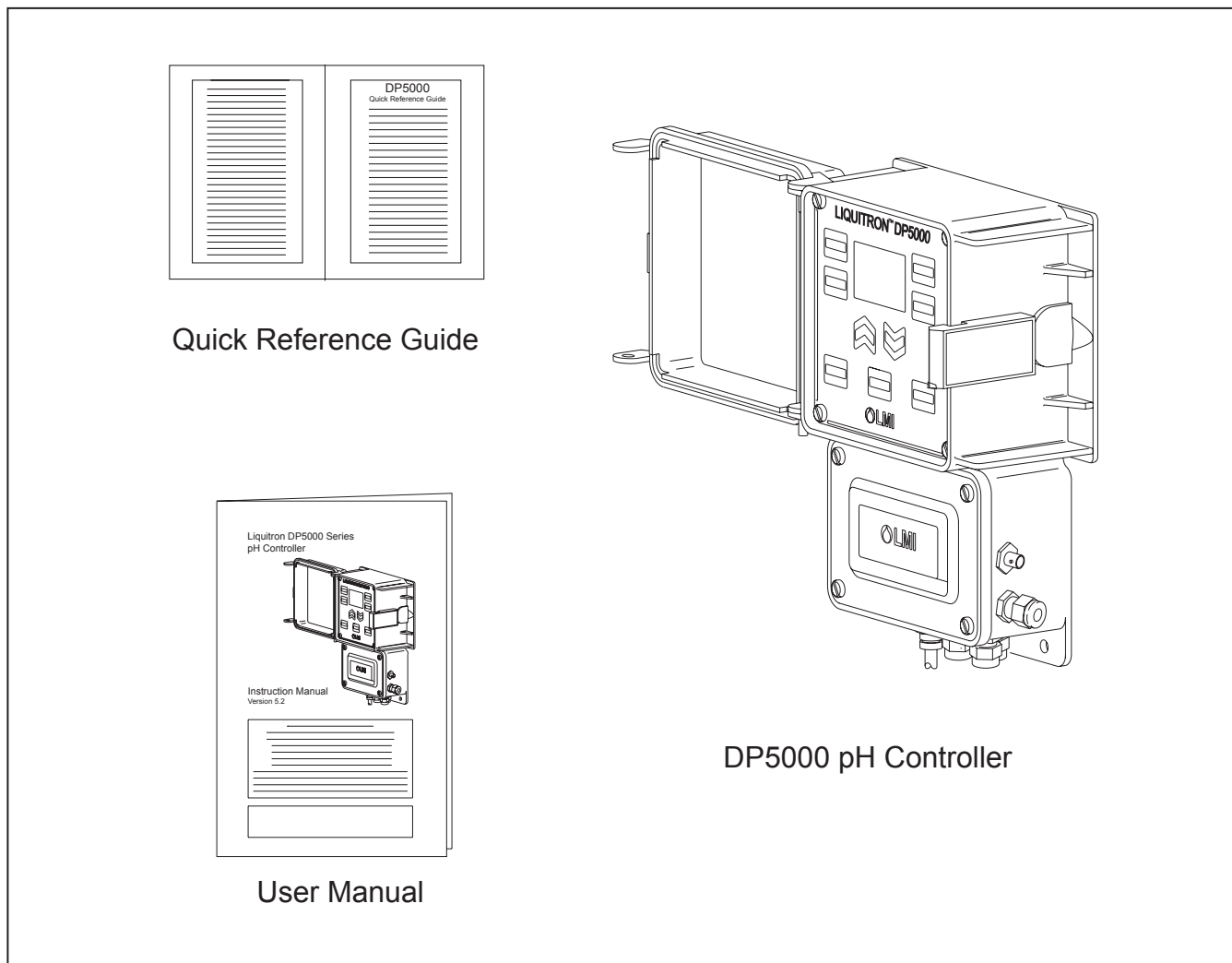

Figure 1. Unpacking Items

3.1 PRE-INSTALLATION

CAUTION BE SURE THAT THE UNIT HAS A PLUG AND VOLTAGE CODE COMPATIBLE WITH THE POWER SOURCE THAT YOU INTEND TO USE.

3.2 ENVIRONMENT

The housing is corrosion and spray resistant but should not be subjected to excessive spray or ambient temperature over 122°F (50°C). Never immerse the unit.

3.3 INSTALLATION

The LIQUITRON™ DP5000 Controller should be mounted on a solid, stable surface. pH adjustment pumps should be installed following the manufacturer's recommendations. For installations requiring longer cables, consult your distributor. The electrode installation will vary, depending on the process used. In general, the temperature electrode and pH electrode should be mounted together, and placed far enough downstream from the source of pH adjusting solution that sufficient mixing may occur, but close enough to eliminate hydraulic lag time of response. Refer to the typical installation diagrams on the following page.

3.4 MOUNTING THE ELECTRONIC ENCLOSURE

The LIQUITRON™ DP5000 control module is supplied with integral wall mounting flanges. It should be hung with the display at eye level, on a vibration-free structure, in a location where liquids will not be splashed on it. All four (4) top-mounting holes should be used for structural stability. The control module requires the following clearances:

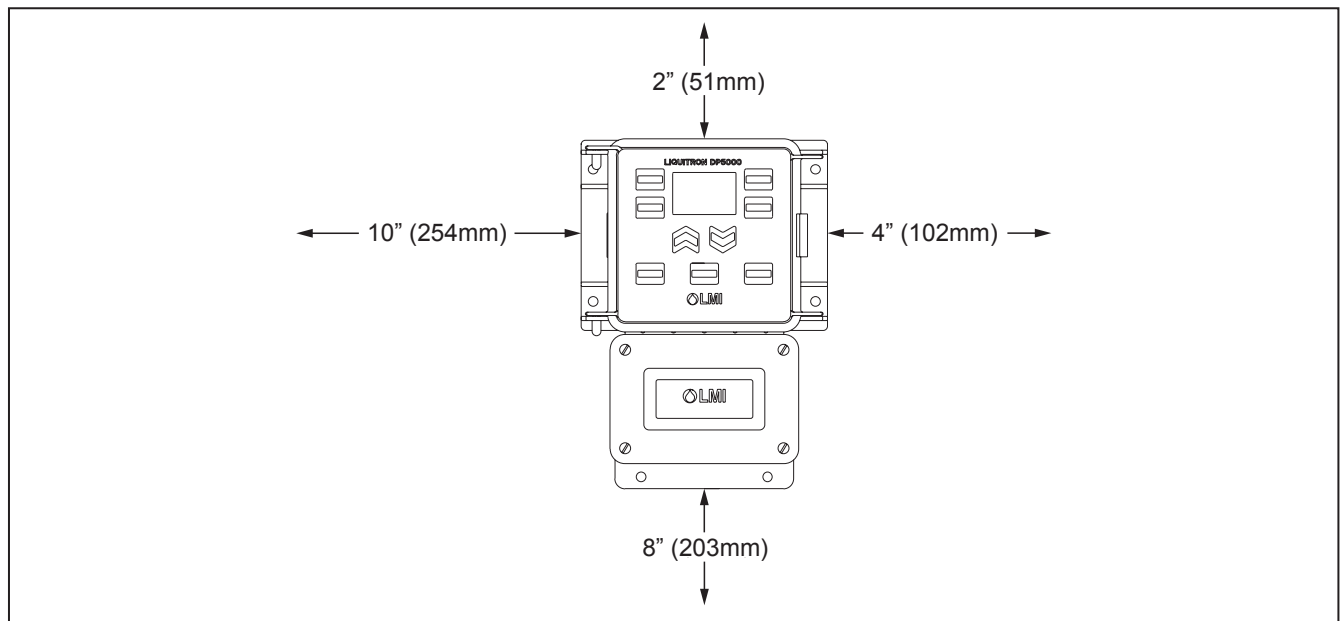

Figure 2. Minimum Clearances

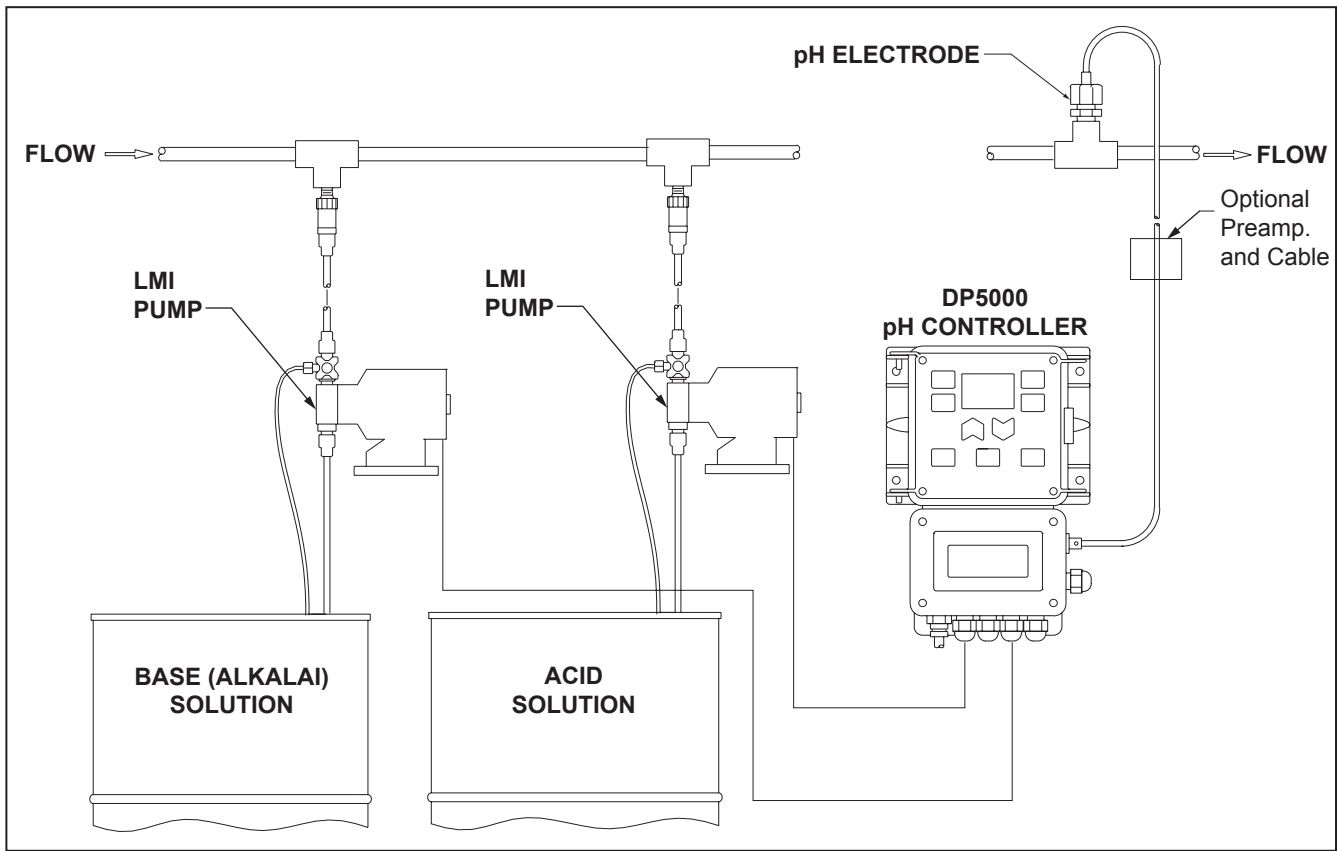

Figure 3A. Typical In-Line Installation

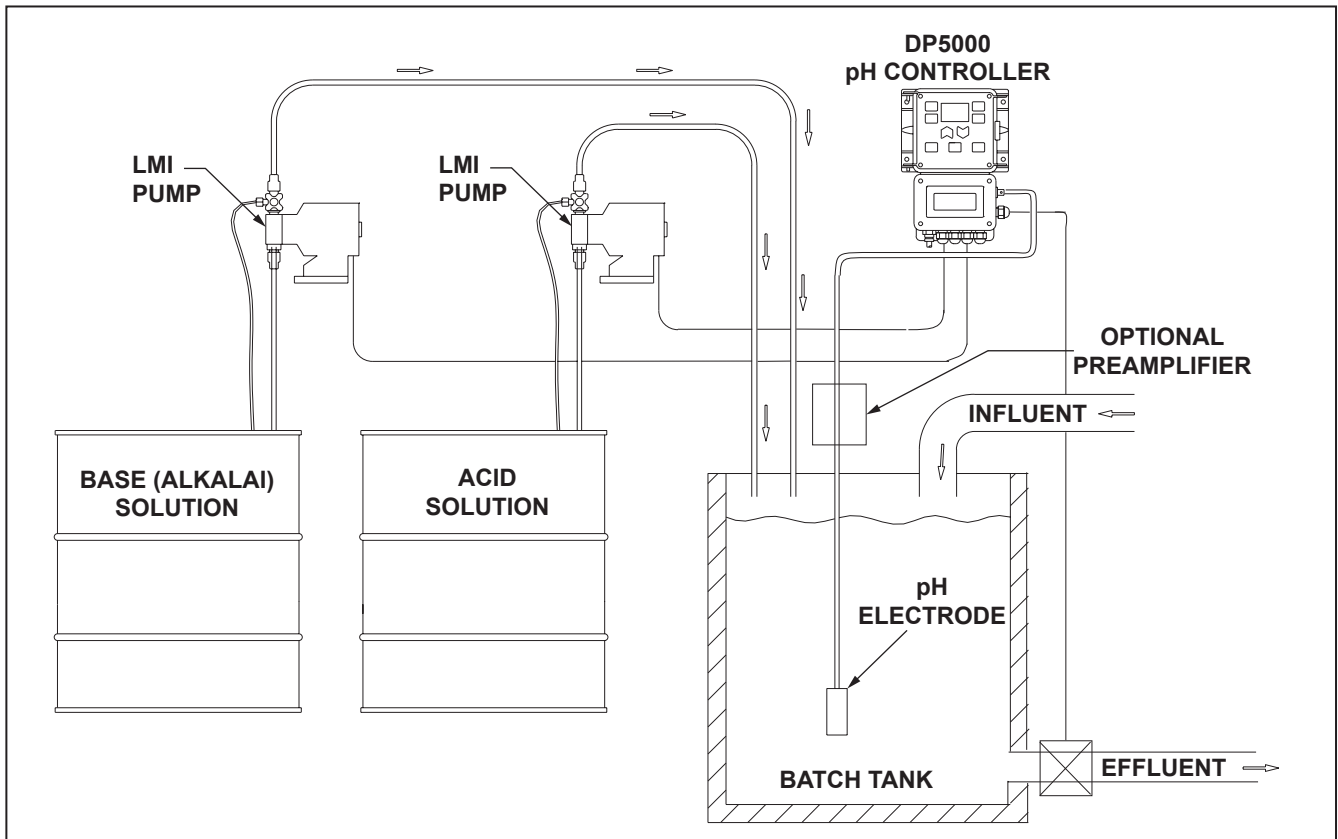
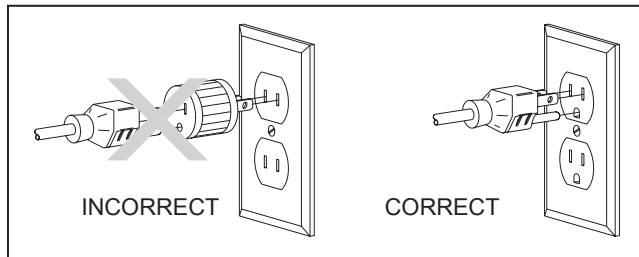

Figure 3B. Typical Batch Installation

3.5 ELECTRICAL INSTALLATION

3.5.1 Electrical Connections

CAUTION TO REDUCE THE RISK OF ELECTRICAL SHOCK, THE CONTROL OR METERING PUMP MUST BE PLUGGED INTO A GROUND OUTLET WITH RATINGS CONFORMING TO THE DATA ON THE CONTROL PANEL. IT MUST BE CONNECTED TO A GOOD GROUND. DO NOT USE ADAPTERS. ALL WIRING MUST CONFORM TO LOCAL ELECTRICAL CODES.



Electrical installation of the DP5000 Series pH Controllers consists of plugging the control module into a proper line outlet. Based on model number, the following voltages and receptacles are required:

Model Number	voltage	Receptacles
DP5000-1A DP5000-1B	115 V, 60 Hz	USA Cord
DP5000-01A DP5000-01B	115 V, 60 Hz	No Cord
DP5000-2A DP5000-2B	230 V, 60Hz	USA Cord
DP5000-02A DP5000-02B	230 V, 50/60Hz	No Cord
DP5000-3A DP5000-3B	230 V, 50 Hz	DIN Cord
DP5000-5A DP5000-5B	230 V, 50 Hz	UK Cord
DP5000-6A DP5000-6B	230 V, 50 Hz	AUS / NZ Cord
DP5000-7A DP5000-7B	230 V, 50Hz	SWISS Cord

Connect the pH adjustment pump(s) to the terminal strip for 'ON / OFF' control (connect to receptacles directly for 115 V models) or to cables for 'PROPORTIONAL' control. Connect the pH electrode to the BNC connector on the right side of the control module. Take care not to twist or strain the wires. If equipped, connect the ATC cable (1000 Ω at 32°F (0°C)) through the cable gland below the BNC connector to the terminal strip. You may optionally connect an alarm, solenoid, flow switch and low level switch. You may also connect the mA connections (with the option fitted). The ± 5 V supply for electrode pre-amplification is also accessed on the terminal strip. There is a 500 Ω maximum resistance for 4-20 mA option (refer to *Figures 4 and 5*).

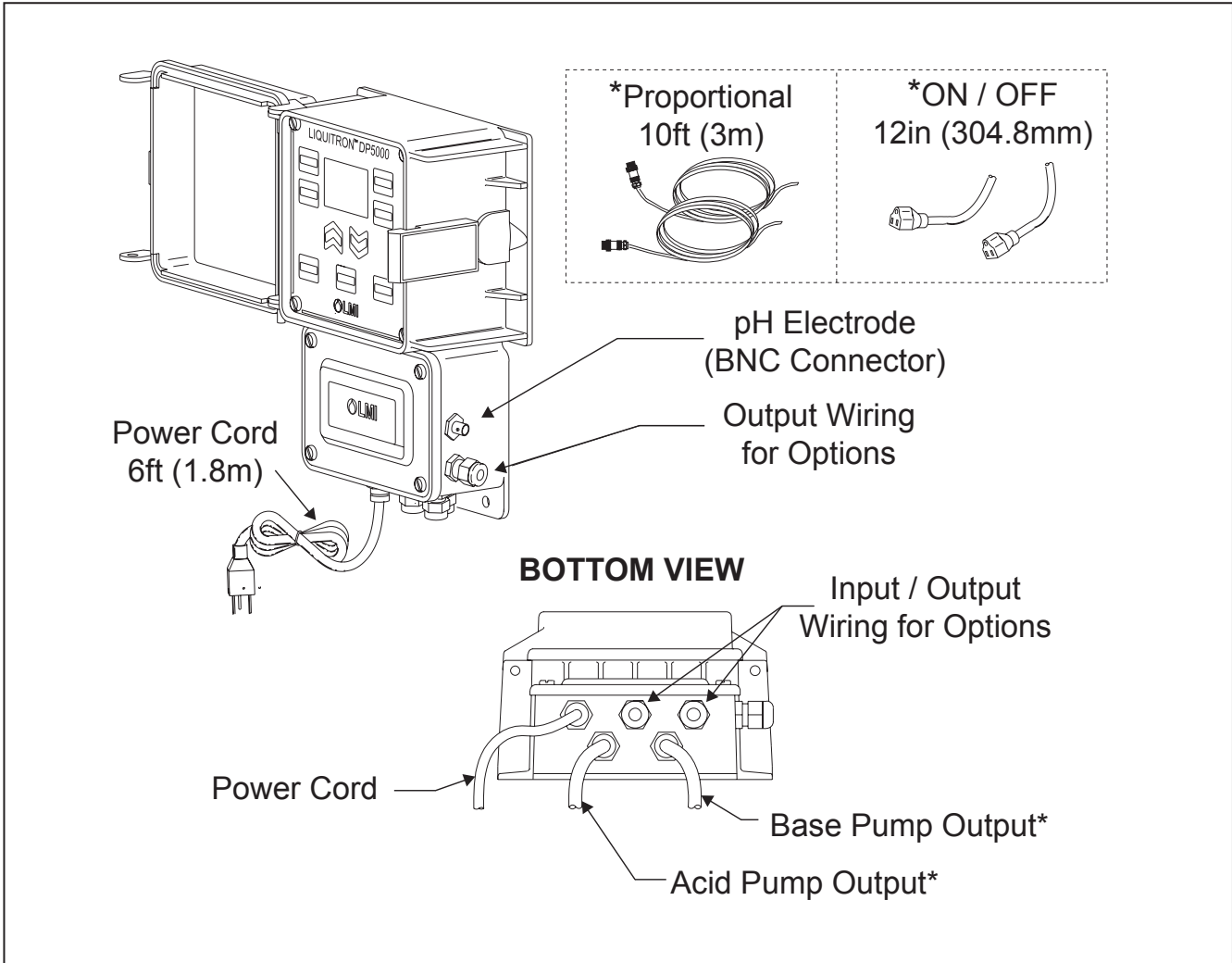
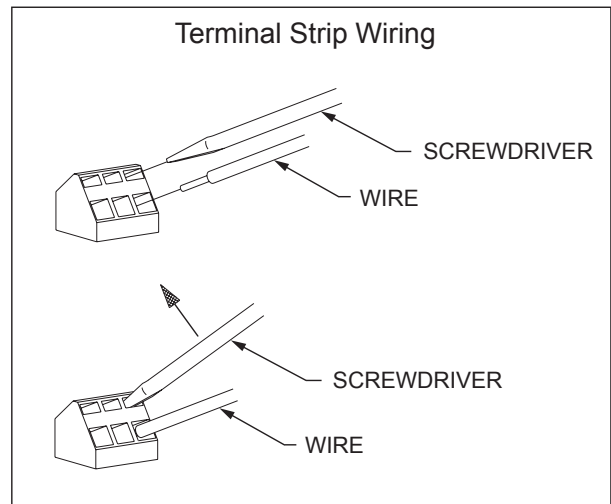
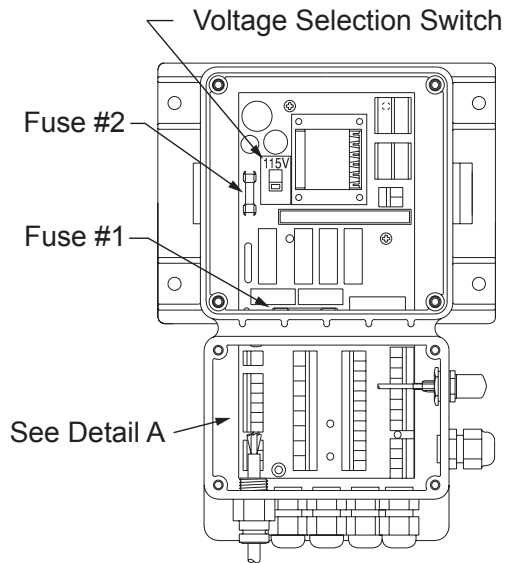

Figure 4. Electrode and Pump Connections



Detail A

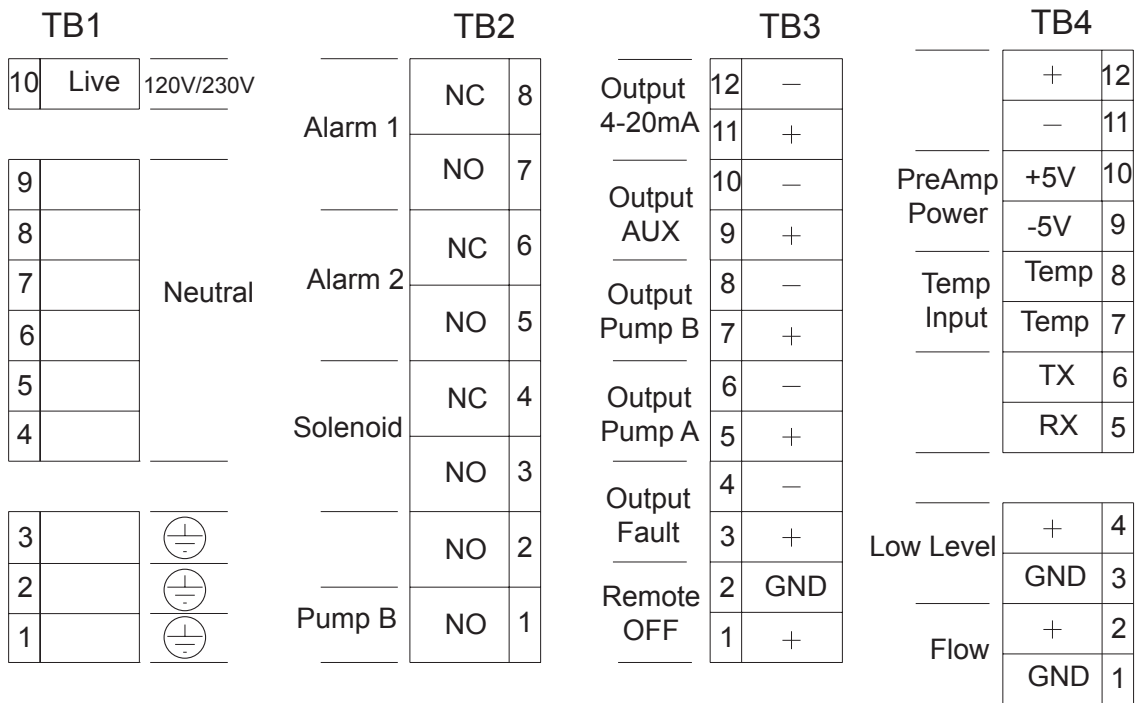

Figure 5. Terminal Strip

SECTION 3 - INSTALLATION

3.5.2 Terminal Board Signal Description

Terminal blocks are TB1-TB4 from left to right, and Pin 1 is at the bottom of each terminal block.

TB1 Terminal Strip	TB1	Pin 1-Pin 3	Earth connection (one for input power connection)
	TB1	Pin 4-Pin 9	Neutral power connection (one for input power connection)
	TB1	Pin 10	AC Mains live input
TB2 Terminal Strip	TB2	Pin 1	Form A contact closed when Pump B (base) is ON
	TB2	Pin 2	Form A contact closed when Pump A (acid) is ON
	TB2	Pin 3-4	Form C contact activated, (if programmed) when pH is within programmed limits (solenoid pump)
	TB2	Pin 5-6	Form C contact activated when Alarm Setpoint 2 exceeded (powered output contacts)
	TB2	Pin 7-8	Form C contact activated when Alarm Setpoint 1 exceeded (powered output contacts)
TB3 Terminal Strip	TB3	Pin 1-2	Opto isolated input - low or short stops pumps (OFF on display)(Remote OFF)
	TB3	Pin 3-4	Opto isolated output - low when alarm condition exists
	TB3	Pin 5-6	Opto isolated output - pulse train to drive Pump A
	TB3	Pin 7-8	Opto isolated output - pulse train to drive Pump B
	TB3	Pin 9-10	Spare, not programmed
	TB3	Pin 11-12	Spare, not programmed
TB4 Terminal Strip	TB4	Pin 1-2	Opto isolated input - flow switch input (add jumper if no flow switch is used)
	TB4	Pin 3-4	Opto isolated input - level switch input (add jumper if no level switch is used)
	TB4	Pin 5-6	Spare, not programmed
	TB4	Pin 7-8	Temperature input (from platinum RTD probe) (polarity sensitive)
	TB4	Pin 9-10	Power voltage source for preamp
	TB4	Pin 11-12	4-20 mA output proportional to pH (programmable limits) (optional) (polarity sensitive)

3.5.3 Field Wiring Instructions

Typical US field installation would include a 6 ft (2 m) AC cord wired and two (2) 1 ft (30 cm) AC receptacles ('ON / OFF' mode) or two (2) 10 ft (3 m) pump drive cables ('PROPORTIONAL' mode) installed. A BNC receptacle would be installed for the pH probe.

Connect the two (2) pumps appropriately. Install the probe, run the cable back to the controller and attach to BNC receptacle. If the probe is farther than 25 ft (7.6 m) from the controller, a pre-amp may be desirable to reduce noise effects. If this is the case, run +5 V/-5 V as required by your preamp. Current draw must not be greater than 10 mA.

If a flow switch and / or low-level tank switch is available, run wires to the controller - entering through one of the spare cable ports. Remove the appropriate jumper(s) and attach the external wires. Polarity does not matter. Wire size #20-22 is adequate.

Alarm relays 1 and 2 are provided to signal an out of tolerance condition externally. These are Form C contacts, providing a common, a normally open and a normally closed connection. These terminals provide power output.

A solenoid drive relay is provided that can be connected to drain a tank when the pH is within programmed limits. This form C contact provides a common, a normally open and a normally closed connection. A delay can be programmed after initially entering this programmed zone, to allow conditions to settle within the tank. The duration of solenoid ON time is separately programmable. Wire size #16-18 is adequate. These terminals provide output power (main voltage).

The optional 4-20 mA PCB provides a fully programmable 4-20 mA output based on the pH readings. The optional PCB plugs into the back of the computer pc board, as shown in *Figure 6*.

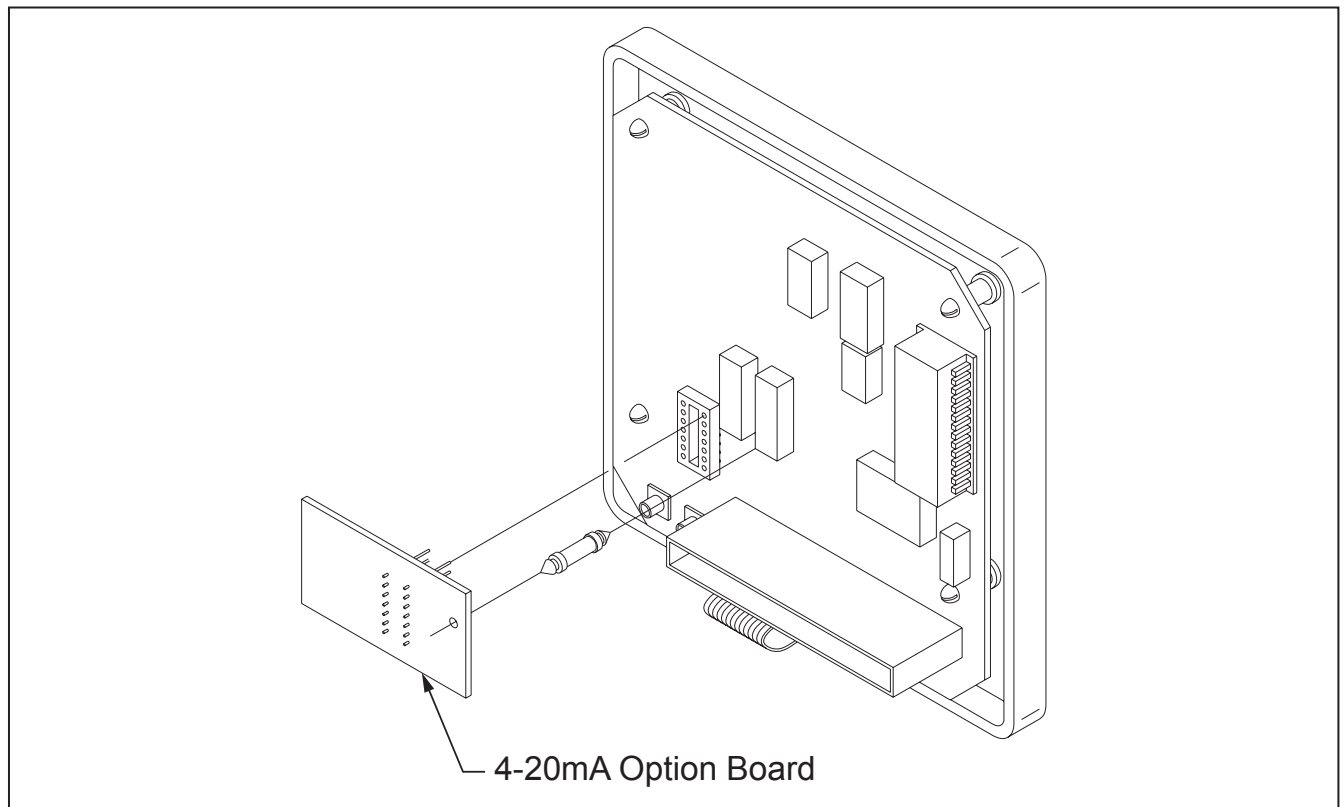

Figure 6. Circuit Board

SECTION 3 - INSTALLATION

3.6 pH ADJUSTMENT PUMP(S)

There are two (2) versions of the DP5000, one is the 'ON / OFF' Output and the second is 'PROPORTIONAL' Output.

The **ON / OFF Output** DP5000 pH Controller will operate any pH adjustment pump(s) which operate on the same line voltage as the controller itself. Combined continuous controlled load must not exceed 4A @ 115 V or 2A @ 230 V. To ensure efficient control, the pumps should be capable of delivering at least 150% of the maximum pumping requirement. Install and calibrate the pumps according to the manufacturer's recommendations.

The **Proportional Output** DP5000 pH Controller will operate any LMI® AA9, AA7, B9, B7, C9, C7 and E7 pump, or any other pump which operates by providing direct proportional response to a modulated pulse input signal. The pumps must be set to the 'external' control mode. To ensure efficient control, the pumps should be capable of delivering at least 150% of the maximum pumping requirement. Install and calibrate the pumps according to the manufacturer's recommendations.

3.7 KEYPAD AND DISPLAY

The DP5000 pH Controller menu allows the user to input all the variables necessary to customize the controller for the application. The keypad is used for all programming (see *Figure 7*).

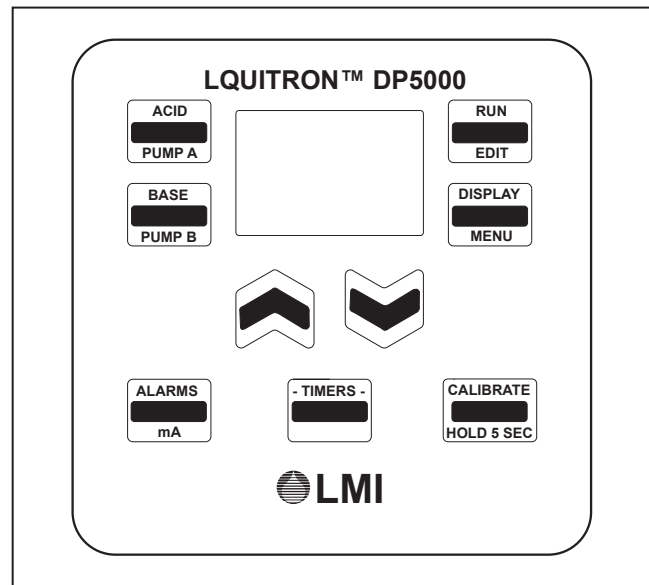

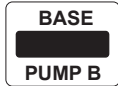



Figure 7. Keypad

Keys:

-  This key is used to set up the control profile for the acid dosing pump. (Holding the key for five (5) seconds will allow priming of Pump A) (Factory setting 90 SPM).
-  This key is used to set up the control profile for the base (alkali) dosing pump. (Holding key for five (5) seconds will allow priming of Pump B) (Factory setting 65 SPM).
-  This key is used to program the high and low alarm points and hysteresis (ON / OFF mode). It also allows programming of the mA output when installed.

SECTION 3 - INSTALLATION

- TIMERS -



This key is used to program 'run times' for Pumps A and B, 'delay times' 1 and 2 for actuating and controlling a solenoid valve (when programmed 'ON' in the advanced features menu). This key also allows setting of the 'manual temperature' and the controller response rate Δ pH. If pump run time is over 11:01 hours, the run time is disabled. The pump will not be stopped and will run continuously.

CALIBRATE

HOLD 5 SEC



This key when pressed will display details of the last successful electrode calibration. (Holding this key for five (5) seconds will allow entry into a new calibration procedure (single or two point)).

DISPLAY



Pressing this key will cause the display to alternate showing various settings. (Holding the key for five (5) seconds will allow entry to the 'advanced features' menu).

RUN

EDIT



This key is used for starting and stopping (run or edit) the pumps and changing set points in the controller. It changes the mode of the controller from 'RUN' to 'OFF.'



These keys are used to change values on the display.



Simultaneously pressing these two (2) keys will lock the keypad to prevent casual tampering. Pressing them a second time will unlock the keypad. (Wait five (5) seconds between locking and unlocking).

SECTION 4 - OPERATION

4.1 DEFAULT SETTINGS

In the default mode, as shipped from the factory without any extended features programmed in the 'menu', the controller is set to operate two (2) dosing pumps towards a single desired pH region as defined by the set points. It will do this in one of two ways, 'ON / OFF' or 'PROPORTIONAL,' shown graphically below:

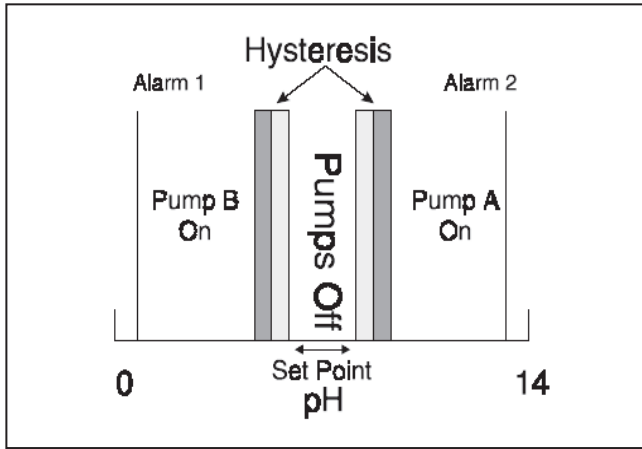

Figure 8. ON / OFF Control

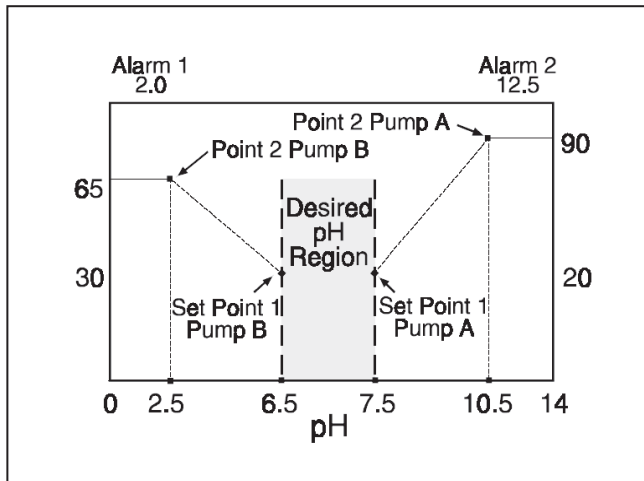

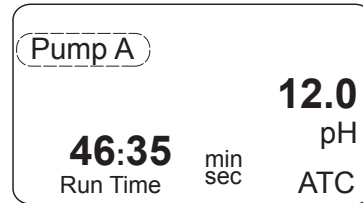

Figure 9. Proportional

When the unit is plugged in, the computer powers up and the display illuminates. The display flashes the pH reading and 'OFF'. This indicates the pumps will not operate and the unit is in the 'OFF' mode. When the  key is pressed the controller starts and switches into the 'RUN' mode.

Example: (Proportional Controller)

This display shows a pH value of 12.0. Pump A is flashing indicating that the acid pump is in operation. The pump will stop pumping after 46:35 minutes if set point is not reached.



For two (2) seconds in every eight (8) seconds the display shows pump speed in pulses / minute. The pulses / minute displayed relates to the pump that is in operation.

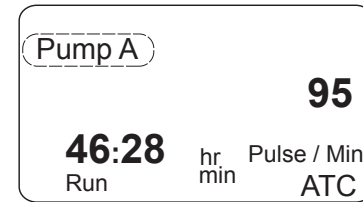

When the pH value exceeds the programmed pH alarm point (12.5), the 'ALARM' flashes and the alarm relay is activated.

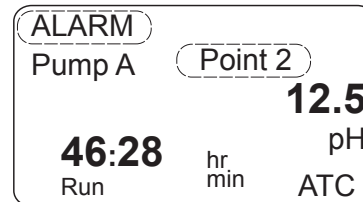

NOTE:
 Throughout this manual, the term 'pulse' is used to describe the mechanical stroke of the pump, as strokes per minute (SPM).

4.1.1 Proportional Mode

The unit is shipped preset at the factory for the 'PROPORTIONAL' or 'ON / OFF' mode. To change the unit to the opposite mode see 'Advanced Menu List,' Option 2, on page 22.

NOTE:
 Controller must be in 'OFF' mode to program changes.

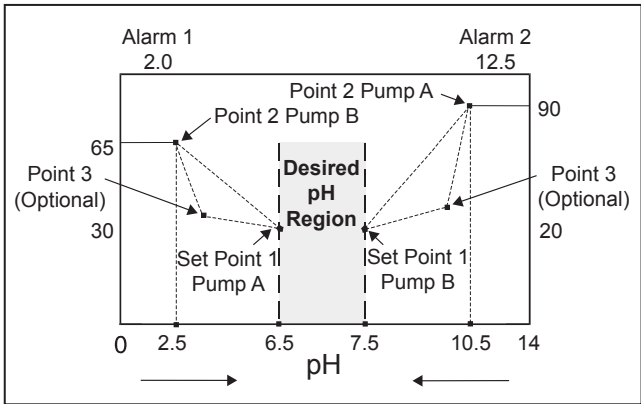



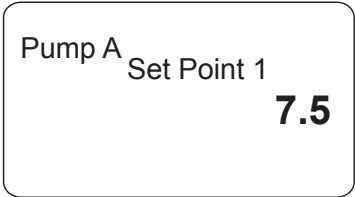





Figure 10. Pump A Control Profile

Pressing  switches the mode back and forth from RUN' to 'OFF'. The pH set points and pump speed (pulses/min) can be changed only in the 'OFF' mode.



1. Press 
2. Press  or  to increase / decrease the pH value of Set Point 1 for turning on 'Pump A'.



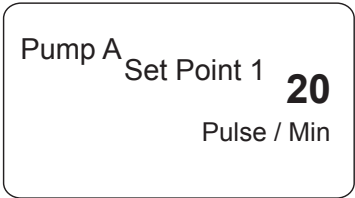



3. Press  again.
4. Press  or  to increase / decrease pump speed (pulse/min) for set point 1.

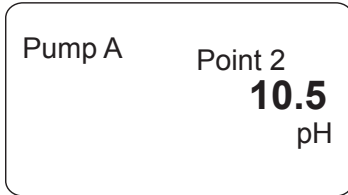

SECTION 4 - OPERATION

5. Press  again.
6. Press  or  to increase / decrease the pH for Set Point 2.



7. Press  again.
8. Press  or  to increase / decrease pump speed (pulse/min) for Set Point 2.

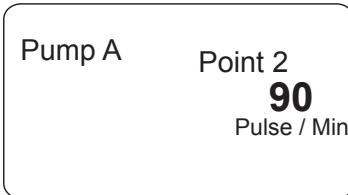

'Pump B' (Base Pump) is programmed in a similar way.

NOTE:

Set points 1 and 2 must be separated by 0.5 pH minimum. If 'Point 3' is selected in the Advanced Features Menu, the user will be prompted to enter a pH value for Set Point 3 and a Pump Speed at Set Point 3. Set points 1 and 3, 2 and 3 must be separated by 0.1 pH minimum.

4.1.2 ON / OFF Mode

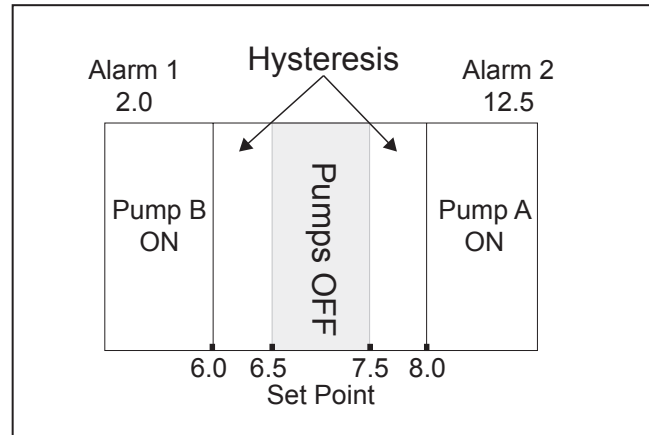



Pump A Control Profile

NOTE:

Controller must be in 'OFF' mode to program changes.



1. Hysteresis values can be set as low as 0.1 pH
2. Lowest setpoint value for pump B is 1 pH
3. Highest setpoint value for pump B is 12 pH
4. Lowest setpoint value for pump A is 2 pH
5. Highest setpoint value for pump A is 13 pH

For 'ON / OFF' controllers with relay outputs (instead of pulse outputs) each pump is programmed as follows:

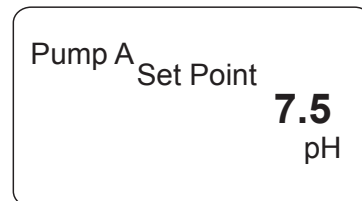
1. Press  to display Set Point.
2. Press  or  to increase / decrease pH Set Point.



SECTION 4 - OPERATION

3. Press  to save programmed Set Point.
4. Press  or  to program Δ pH (Hysteresis) period for relay. In this example, 'Pump A' will turn ON at a pH of 8.0 (set point + Δ pH). 'Pump A' will turn OFF when pH drops to 7.5.

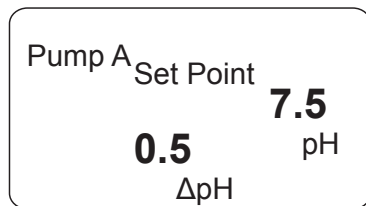

'Pump B' (Base Pump) is programmed in a similar way.

In this example, 'Pump B' will turn ON at a pH of 3.5 (set point - Δ pH) and will turn OFF when pH reaches 4.0.

It is highly recommended that the hysteresis (pump OFF function) be used to prevent relay chatter.

The function of the hysteresis is to prevent pump relay chattering. It operates by allowing the pump to be turned ON when the control point plus (or minus) the hysteresis value has been met, but does not allow the pump to turn OFF until the control point has been met. The chosen value will be used for both upper and lower set points.

The hysteresis, or dead band, designates how many pH units beyond set point the pump runs before turning OFF. Any value from 0 to 14.00 is acceptable. If use of this function is undesirable, set it to 0.

Example: If the lower set point is pH 4.0 and the hysteresis has been set at 0.50, a falling pH will cause the pump to activate at pH 3.50 and it will run until reaching set point (4.0).

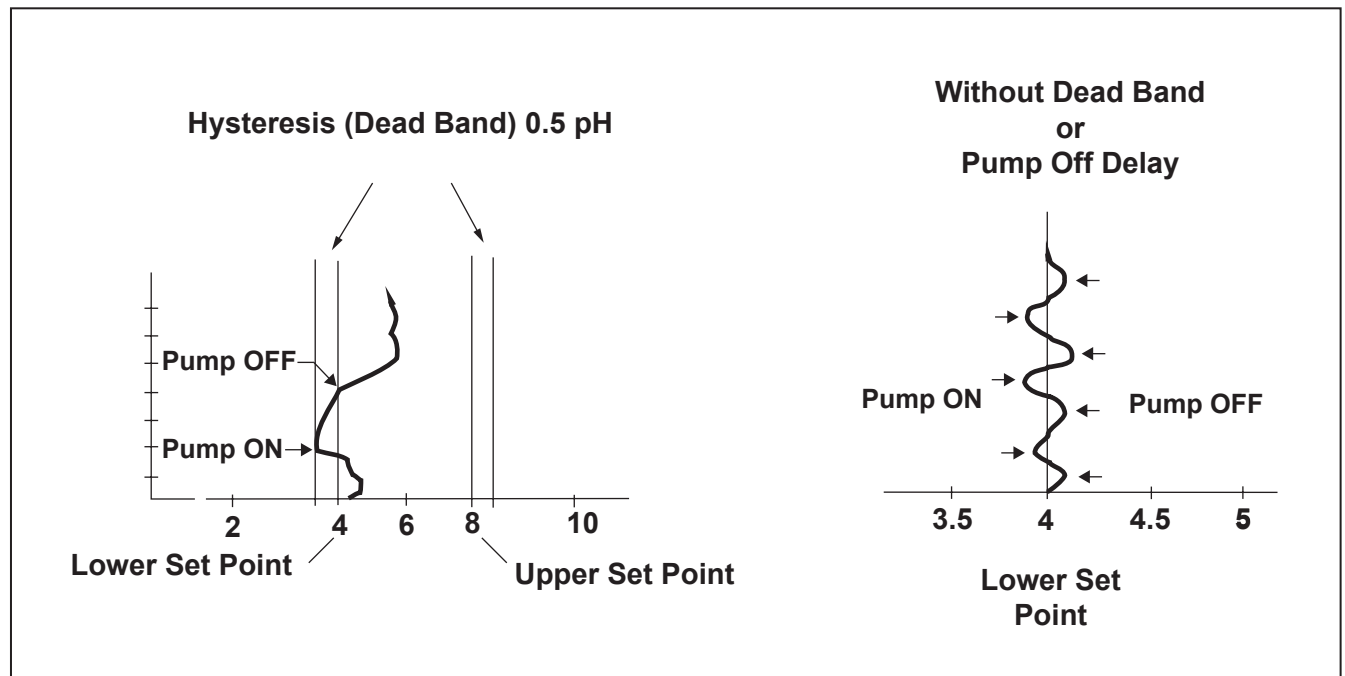



SECTION 4 - OPERATION



4.2 ALARMS

NOTE:

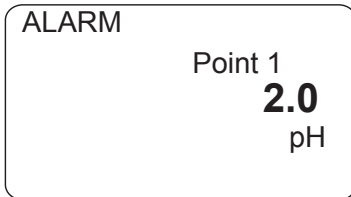

Controller must be in 'OFF' mode to program change Set Points.

1. Press  to display Alarm data.
2. Press  or  to program Alarm Point 1 (low pH). (Pump B)



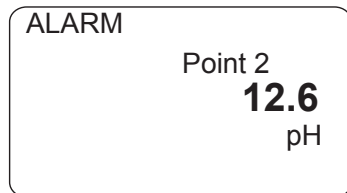

3. Press  to save Alarm Point 1 value and to move to Alarm Point 2.
4. Press  or  to program Alarm Point 2 (high pH). (Pump A).



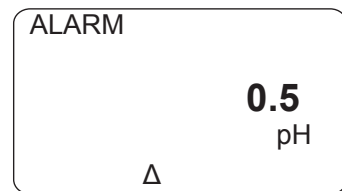

5. Press  to save Alarm Point 2 value and to move to Alarm Hysteresis.
6. Press  or  to program Alarm Hysteresis. This is the point where the alarm turns OFF.

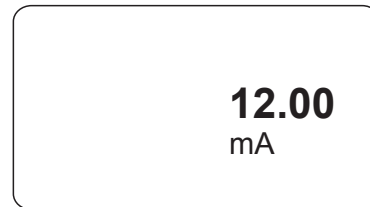

If the 4-20 mA option board is installed, the following screens will appear. If these do not appear and the 4-20 mA PCB is installed, go to Section 4.6, Advanced Menu, and program option "7" to "1" and option "6" to "1".

7. Press  to display current mA output value.
8. Press  again to program the 4-20 mA output.



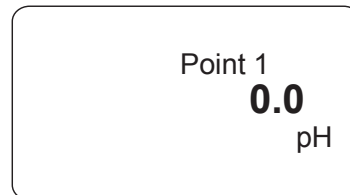

9. Press  or  to select the pH value for Point 1 mA output. Default is 4 mA = 0 pH, 20 mA = 14 pH.



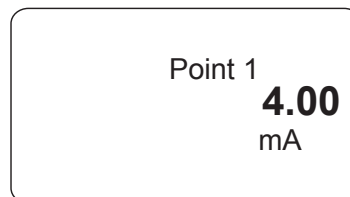

10. Press again. Press  or  to select the mA value at Point 1.

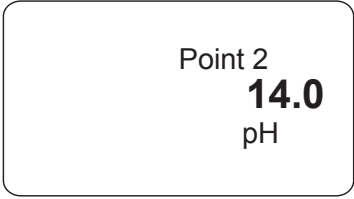

11. Press  again. Press  or  to select the pH value for Point 2 mA output.



12. Press  again. Press  or  to select the mA value at Point 2.

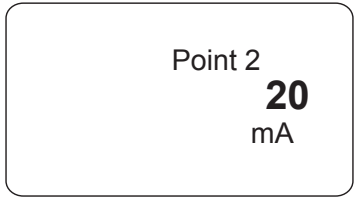

4.3 CALIBRATION (VIEWING LAST CALIBRATION DATA)

Press the  key once.

CALIBRATE will be visible and the ‘mV/pH’ and ‘%’ (slope) of the previous calibration will be displayed. The display will alternate between ‘mV/pH’ and ‘°C.’

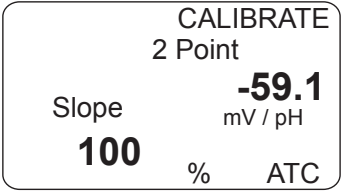

‘2 Point’ indicates that the previous calibration was a two-point calibration.

‘1 Point’ indicates that the previous calibration was a one-point calibration.

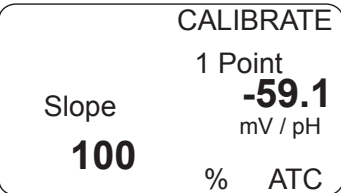

4.4 NEW CALIBRATION

For two-point calibration, the default settings are Buffer 1 = 7.00 pH and Buffer 2 = 10.00 pH but these values may be changed.

Because it is not always possible to transfer the temperature probe from the process to the pH buffer, automatic temperature probe detection can be switched OFF in pH calibration mode.

The calibration parameters (temperature, ATC (automatic temperature compensation) or manual, buffer pH and one or two point calibration) of the previous calibration are the initial values for the current calibration.

NOTE:
If the LMI® temperature cable and probe are connected, then the computer automatically selects and uses this ATC (automatic temperature compensation) during calibration. If no temperature probe is connected, then ‘MANUAL’ will be selected during calibration. You must manually measure the temperature of the process being controlled and enter that value here.

NOTE:
The unit must be placed in the ‘OFF’ mode. The unit cannot be calibrated in the ‘Run’ mode.

SECTION 4 - OPERATION



Calibration (e.g., 2 Point)

1.  + 5 seconds

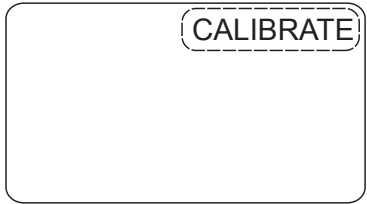

Hold the 'CALIBRATE' key down for five (5) seconds. 'CALIBRATE' will start flashing.





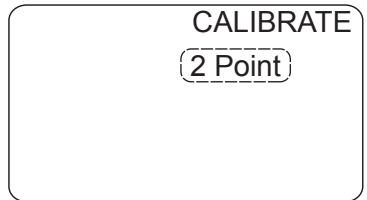

2. Press  again.

'2 Point' will start flashing. Use the  or  keys to toggle between '1 Point' and '2 Point.'

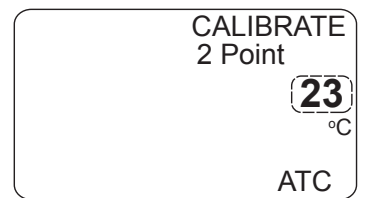

3. Press  again. 'ATC' (or 'MANUAL') will start flashing. Use the  or  keys to toggle between 'ATC' and 'MANUAL' temperature.



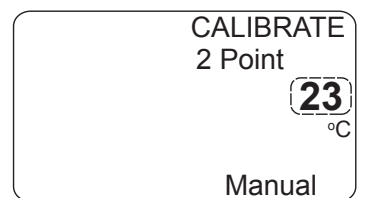

4. Press  again. Use  or  keys to program actual temperature of buffer.





It is not possible to program temperature if 'ATC' is selected.

NOTE:

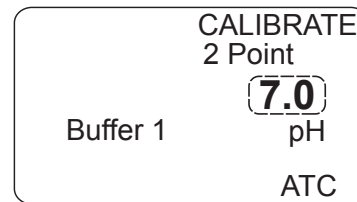

Automatic temperature probe detection can be over-ridden in pH calibration mode. If the ATC probe is not connected, the controller will not detect it and only the 'MANUAL' temperature option above will be displayed.

5. Press  again. The 'Buffer 1' value will start flashing. Use  or  keys to program 'Buffer 1' pH (or leave at 7.0).



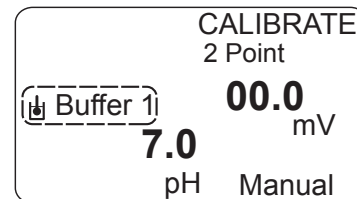

6. Press  again. The  symbol will prompt you to put the probe in 'Buffer 1'. Wait for the mV value to settle.

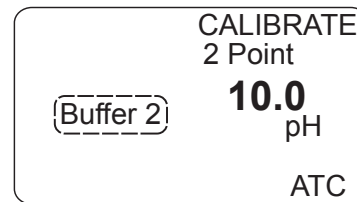

7. Press  again. This will accept the first calibration value and will display the 'Buffer 2' pH. Use  or  keys to program 'Buffer 2' (or leave) as desired.



8. Press  again and the  symbol will prompt you to put the probe in 'Buffer 2'. Wait for the mV value to settle.

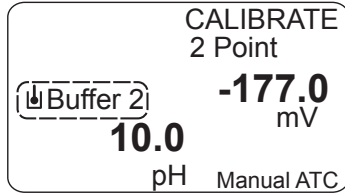

9. Press  again. This will accept the second calibration value and will display the 'mV/pH' (and '%' Slope) result of the calibration.

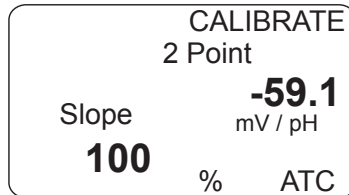

10. Press  again to accept this calibration and exit calibration mode. Press any other key to abort calibration.

NOTE:

For a single-point calibration, only one (1) buffer is used. The theoretical value for pH 7.00 is used to complete the Calibration Curve.

If the calibration is unsuccessful (slope < 70% or offset > ± 30 mV) and 'ERROR CALIBRATE' and 'E7' are displayed; the calibration should be repeated or else the controller reverts to using the 'last successful' calibration performed.

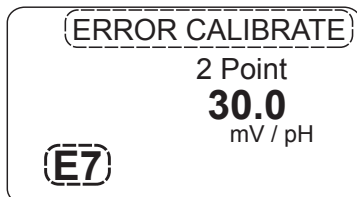

A slope of less than 70% indicates a dirty / faulty probe or contaminated buffer.

4.5 PUMP TIMERS AND SOLENOID VALVE CONTROL TIMERS

It is not possible to change timer values while in 'RUN' mode. Unit must be in the 'OFF' mode to change values and settings.

4.5.1 Pump Run Time

This timer is set to the maximum time the pump can be ON. If the timer is set to over 11:01 hours, the pump will run continuously.

This timer is started when a pump is ON and the pH value is outside the set points. The controller will stop the pumps when the time reaches '0' and activate 'ALARMS'. The run time is reset each time the pH enters the desired set point region.

4.5.2 Solenoid Delay Pump Valve Time

The Solenoid Valve Relay output may be activated when the pH is within the set points for the time specified by 'Delay 1'. This may be used for system integration and for emptying a batch tank etc.

The 'Delay 1' Timer defines the period to allow pH and system parameters to settle.

The 'Delay 2' Timer (ON time) defines how long the valve will stay open. When these Delay Timers are active, pump dosing cannot take place but the DP5000 will monitor the pH. The 'Delay 2' timer starts when the outputs are activated. If the pH drifts outside of the set point and range, the solenoid relay will be deactivated.



If a 'Delay 2' time goes below one hour, then the display will change to 'minutes : seconds' from 'hours : minutes'.

SECTION 4 - OPERATION

4.5.3 Setting Timers

NOTE:

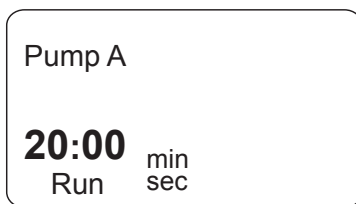

The unit must be in the 'OFF' (edit) mode to change the timer settings. For proportional mode pump run time must be set above 11 HR 01 Min to ensure continuous operation.

1. Press the  key to view the run time for 'Pump A'.
2. Use  or  to adjust to desired maximum run time.



NOTE:

The 'hr : min' will change to 'min : sec' automatically as the run time is reduced below one (1) hour.

3. Press the  key to advance to run time for 'Pump B'.
4. Use  or  to adjust to desired maximum run time.

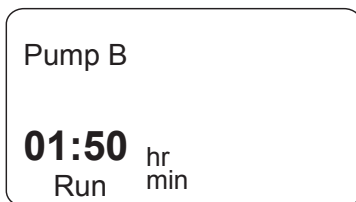

NOTE:

The 'hr : min' will change to 'min : sec' automatically as the run time is reduced below one (1) hour. **Delay Timers are factory set in the deactivated mode.** The 'Delay 1 and Delay 2' Timers are activated / deactivated in the 'Advanced Features Menu.' These screens will not display when the delay option is deactivated.

4.5.4 Solenoid Valve Control

5. Press the  key to advance to 'Delay 1' time (if activated). 'Delay 1' is the wait time after pH enters the desired region, before the Solenoid is activated.



6. Press the  key to advance to 'Delay 2' time (if activated). 'Delay 2' is the Solenoid 'ON' time.



NOTE:

If the pH should go out of the desired range during 'Delay 1' or 'Delay 2', the Solenoid cycle will terminate. It will start again from zero when pH re-enters the desired region. If pH remains in the desired region, the controller will enter 'OFF' mode at the end of the Solenoid 'ON' time. The controller turns 'ON', again in one minute and the cycle repeats.

7. Press key  to advance to 'Response Rate'. This is programmed in Δ pH units.

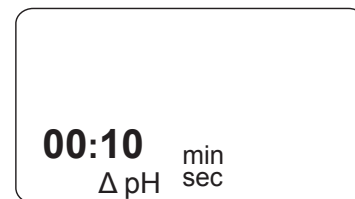

SECTION 4 - OPERATION

The smoothing of the input signal is determined by delta (pH) time. The 'Response Rate' is the time that the computer display takes before it updates the pH readings.

The following values can be programmed (min : sec):

00 : 01 00 : 10 00 : 20 00 : 30. 04 : 00
(In increments of 10 seconds)

When 00 : 01 is programmed the controller responds to a change in input in one (1) second.

If 00 : 10 is selected the controller responds to a change in input in ten (10) seconds. (i.e., The value displayed is the average of the 10 previous 1 second readings.)

Examples:

The sampling time (delta) is 00 : 10 and the current reading is 2.00 pH.

When the pH input is increased instantaneously to 12.00 pH, the display will respond as follows:

Seconds	0	1	2	3	4	5	6	7	8	9	10	11
pH	2	3	4	5	6	7	8	9	10	11	12	12

If the sampling was 00 : 01 seconds, the response would be:

Seconds	0	1	2	3	4	5	6	7	8	9	10	11
pH	2	12	12	12	12	12	12	12	12	12	12	12

Press the  key to advance to set temperature. This setting is relevant when no temperature probe (1000 Ω platinum RTD) is connected.



4.5.5 Display Key

While in the Run Mode the  key can be pressed once to display current parameters. Each screen will come up for three (3) seconds and then returns to pH display or System Run automatically (screens shown below are: mV, °C, and mA).

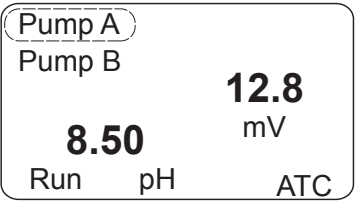

+ 3 Seconds

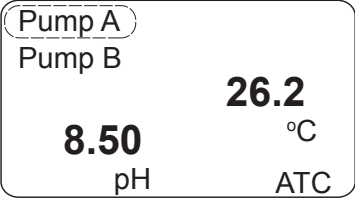

+ 3 Seconds

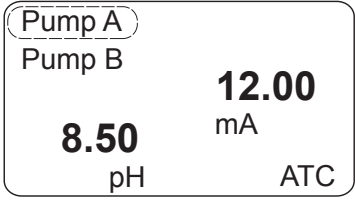

SECTION 4 - OPERATION

Similarly, the Pump Control Points can be displayed while in the 'RUN' Mode by pressing the 'Pump A' or 'Pump B' keys once.

Press  and the following screens display:

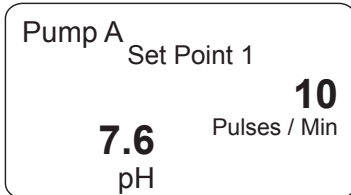

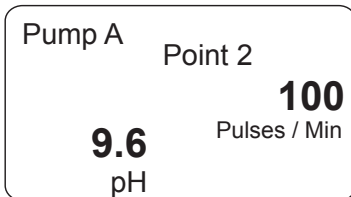

+ 3 Seconds



4.6 ADVANCED MENU

Holding the  key for five (5) seconds accesses the 'Advanced Features' Menu, and allows these settings to be changed.

Press the 'DISPLAY / MENU' key for five (5) seconds while the controller is in the 'EDIT' or 'OFF' mode.

The first item displayed is the software revision. Pressing 'Display / Menu' again cycles to the first option. The first number is the option. The second is the setting. Use the  or  to change the setting.

OPTION	SETTING	
1	1	Control returns to Run 60 seconds after last keypress
	0	Run/Edit key is On/Off
2	1	On/Off Control
	0	Proportional Control (and On/Off)
	2	Proportional Control
3	1	Point 3 Programming Enabled
	0	Point 3 Programming Disabled (Two point only)
4	1	Solenoid programmed to switch on after programmed time 'DELAY 1' and to switch Off after programmed time 'DELAY 2'
	0	Solenoid Disabled
5	1	(NA)
	0	
6	1	mA Enabled - Option Board must be fitted
	0	mA Disabled
7	1	Allows editing of #5 & #6
	0	Lockout #5 and #6

NOTE:

The Option Board (37830) is required for Option 6.

5.1 pH ELECTRODE AND CABLE

The most frequently replaced part is the pH electrode, which will deteriorate with age. Refillable electrodes should be checked for level frequently, and replenished with filling solution as necessary. An electrode may also fail because of:

1. Aging. (slow response to changing pH)
2. Coatings over the glass bulb. (slow response to changing pH)
3. Abrasion of the glass bulb. (shift in calibration)
4. Chemical attack.
5. Breakage.

If you experience instability or lack of response, check the electrode, replace if necessary and recalibrate. Follow manufacturer's recommendation for cleaning the electrode. Take care not to damage input cables, or allow the connections to get wet.

SECTION 6 - TROUBLESHOOTING

Troubleshooting and repair of the malfunctioning unit should only be attempted by qualified personnel using caution to ensure safety and limit unnecessary damage.

Should an error or alarm condition occur, the controller will alert the operator by flashing an 'ERROR MESSAGE'. These messages are depicted on the following page with a brief explanation.

6.1 ERROR MESSAGES

NOTE:

Turn system OFF to clear error message.

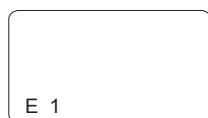

E1 = LOW LEVEL SWITCH

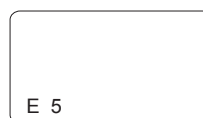

E5 = Pump B 'LOCKOUT'

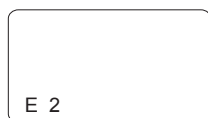

E2 = FLOW SWITCH

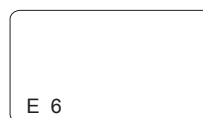

E6 = Pump A 'LOCKOUT'

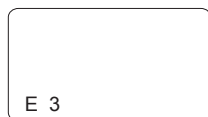

E3 = ALARM 1: LOW pH (PUMP B)

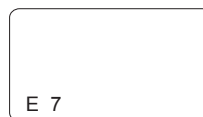

E7 = CALIBRATION ERROR
Probe is out of Manufacturer's Limits

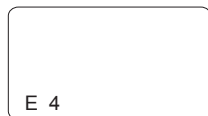

E4 = ALARM 2: HIGH pH (PUMP A)

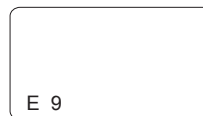

E9 = FAULTY / DISCONNECTED PROBE

SECTION 7 - DP5000 SPECIFICATIONS

Power Requirements	115 VAC \pm 15%, 60 Hz
	230 VAC \pm 15%, 50 Hz
	Voltage input selectable via a selector switch located on the I/O PCB.
Inputs	Flow Switch, Remote ON / OFF, Spares.
	All low voltage inputs active low, i.e., the active state is when the switch is closed.
	The switch must be capable of switching 2 mA at \pm 15 VDC.
Outputs	Pulse Pump A and B, Alarm.
	All low voltage outputs capable of switching 2 mA at + 24 VDC.
	The pulse output frequency range will be 0-100 per minute.
	The pulse output active low. The pulse width 100 ms in the active (low) state.
	Output Type: Opto-Isolated NPN transistor open collector configuration.
Keypad	Nine key membrane keypad with tactile response.
	Material: (The switches are multiplexed 3 x 3)
	Actuation Force: Polyester with a hard coat finish
	Travel: 2.6 N to 3.3 N
	Termination Connector: 0.65 mm 6-way gold plated Berg clincher type 65801-035
Temperature Input	The temperature input interfaces to a platinum 1000 ohm RTD probe.
	Probe: PT1000 (Platinum, 1000 Ω base resistance)
	Circuit Accuracy: \pm 0.9°F (\pm 0.5°C)
	Temperature Display: 32°F to 212°F (0°C to 100°C)
	Temperature Resolution: \pm 1.8°F (\pm 1°C)
Probe Input	Accuracy: \pm 0.02 pH (500M Ω probe ambient cycle 32°F to 113°F (0°C to 45°C))
	Resolution: 0.01 pH
	Input pH Range: 0-14 pH
	Input Impedance Differential: 1013 Ω
	Input Impedance Common: 1016 Ω
	ESD Protection: 700 V
Relays	Fuse protected.
	Alarm Relays (2): Electromechanical
	Solenoid Valve Relay (1): 115/230 VAC, 10 A/6 A
	Current/Voltage Rating: 10A, 115 VAC or 6A, 230 VAC
	Contact Type: Normally open and normally closed contacts (FORM C) Change over relay
	Pump ON/OFF Relay (2) (ON/OFF CONTROL): 115 V/230 VAC, 10 A/6 A (NO) ON/OFF Relays are Fuse Protected (FORM C). Normally open relay
	Fuse: 4 A, 250 VAC time delay (Anti-surge)

SECTION 7 - DP5000 SPECIFICATIONS

LCD Display		Operating Voltage: 5 V
		Operating Temperature 32° F to +122° F (0° C to +50° C)
		Viewing Area: 1.2 x 1.8 inches (30 x 46 mm)
		Backlight: An 8 emitter (dual LED type), double row, reflective backed, backlight module will be used. The light output color and reflective backing color will be high performance green.
Memory Backup		EEPROM
		Data Retention No Power: 10 year minimum
Pre-amplifier Output Voltages		Voltage: ± 5 V
		Output Voltage Tolerance: $\pm 5\%$ maximum
		Current Output: ± 10 mA maximum
Optional Output		4-20 mA Load: 500 Ω maximum resistance
		Accuracy: ± 0.2 mA - The 4-20 mA isolated
	Control Outputs	(Pump A / Pump B) (Proportional Control): Opto-Isolated Open Collector (2 mA)
		Fault: Opto-Isolated Open Collector (2 mA)
	Control Inputs	Remote ON / OFF: Opto-Isolated (2 mA)
		Flow Switch: Opto-Isolated (2 mA)
		Low Level Input: Opto-Isolated (2 mA)
		Aux (spare): Opto-Isolated (2 mA)
Environmental		Printed Circuit Boards conformally coated
		Operating Temperature: 32°F to 122°F (0°C to 50°C)
		Enclosure: IEC IP65, NEMA 4X
Mechanical		Two printed circuit boards (3 if option installed)
		Control Board: (Microcontroller & Display) - Low Voltage
		Terminal / Power Board: Transformer, fuses, terminal blocks, relays
		Option Board: (4-20 mA output) - Low Voltage

SECTION 8 - PROGRAM LOG

For record keeping, a program log is provided below.

	Proportional		ON / OFF	Proportional		ON / OFF
	Pt 1	Pt 2		Pt 1	Pt 2	
Pump A Set Point	7.5	10.5	7.5			
Pump A Pulses/Min	20	90	///			
Pump B Set Point	6.5	2.5	6.5			
Pump B Pulses/Min	30	65	///			
Hysteresis						
Hysteresis 1	///	///	0.5			
Hysteresis 2	///	///	0.5			
Alarms						
Alarm 1	2.0 pH					
Alarm 2	12.5 pH					
Hysteresis	0.5 pH					
mA Response						
Current Low	4.0 mA					
Signal Low	4.0 mA					
Current High	4.0 mA					
Signal High	4.0 mA					
Timers						
Pump A On-Time	20:00 Min					
Pump B On-Time	20:00 Min					
Sampling Time	20:00 Min					
Temperature						
Delay to Solenoid ON	5:00 Min					
Solenoid On-Time	5:00 Min					
Temperature	24oC					
Calibration						
Number of Points	2					
Buffer Temperature	Manual					
Buffer Temperature	24.0					
Buffer 1	7.0					
Buffer 2	10.0					

SECTION 9 - PARTS LIST

Key No.	Part No.	Description
1	34691	Housing, Machined
2	32186	Screw, 4-40 x 0.37
3	32187	Nut, 4-40 Flush
4	32209	Latch, Machined
5	34270	I/O Board Assembly
6	34716	Standoff, Self Adhesive
7	31632	Screw, #6 x 0.38
8	34329	BNC Cable Assembly
9	34330	Ribbon Cable Assembly
10	25957-1	Cord Clamp (PG-9) Clamp for female outlet power cord)
11	36810	Dowel
12	31571	Clamp, Cord (PG-9) Clamp for 4pin cable
13	34074	Gasket, Foam
14	34088	Cover, Utility Box
15	30588	Label LMI Logo
16	37524	Front Panel Assembly
17	31617	Cover, Liquitron™
18	32094	Label, Housing cover LMI
19	32211	Cap, 0.125 x 0.38
20	32352	O-Ring, Sponge
21	32395	Screw, Self-Tapping
23	48461	Cord, Power, 115V, NEMA 15-R - DP5000-XA (ON / OFF)
	33636	4-Pin Cable - DP5000-XB (Proportional)
24	34930	Terminal Cover Label
26	30749	Power Cord 115V - DP5000-1A/B
	30751	Power Cord 220V US - DP5000-2A/B
	30752	Power Cord DIN - DP5000-3A/B
	34783	Cord Assembly UK - DP5000-5A/B
	30754	Power Cord AUST - DP5000-6A/B
	34784	Cord Assembly SWISS - DP5000-7A/B
27	37830	4-20mA Circuit Board Assembly

SECTION 10 - EXPLODED VIEW

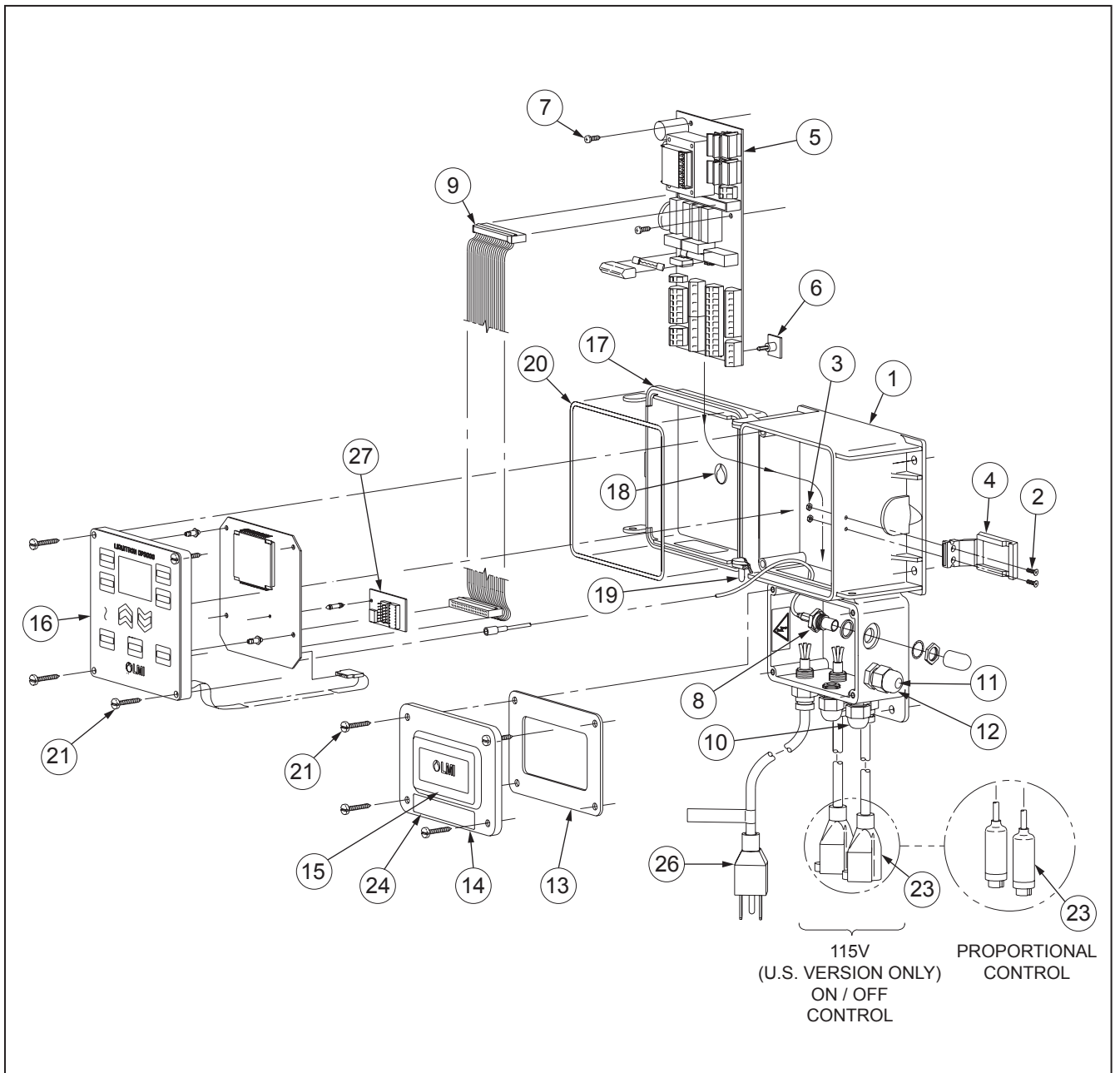

LMI® is a registered trademark of Milton Roy, LLC.
LIQUITRON™ is a trademark of Milton Roy, LLC.
© 2015 Milton Roy, LLC.

info@miltonroy.com
www.lmipumps.com

