

# Operation and Maintenance Manual



## KML-SERIES

*Peristaltic Metering Pump / Operation and Maintenance Manual*





**LMI**<sup>®</sup>

# KML - SERIES

## Table of Contents

<b>1   INTRODUCTION</b> .....	<b>3</b>	<b>6   OPERATING MODES</b> .....	<b>30</b>
1.1 - How to use this maintenance manual .....	3	6.1 - Manual Mode .....	30
1.2 - Training of the user and instructions .....	3	6.2 - Remote Mode .....	30
1.3 - Handling and Storage .....	3	6.2.1 - SCADA .....	30
1.4 - Pump Specifications .....	4	6.2.2 - Industrial protocols .....	32
1.5 - Nameplate Detail .....	4	6.2.2.1 - Modbus RTU .....	33
1.6 - Service Point information .....	5	6.2.2.2 - Modbus TCP .....	33
<b>2   MODEL DESCRIPTION CHART</b> .....	<b>6</b>	6.2.2.3 - RS 485 .....	34
2.1 - Model Code Explanation .....	6	6.2.3 - Batch / Dose Mode .....	34
2.2 - Materials Of Construction .....	7	6.2.3.1 - Dosing .....	34
2.4 - Available Tube Assemblies .....	8	6.2.3.2 - Batching .....	35
2.5 - Dimensions .....	8	<b>7   MAINTENANCE</b> .....	<b>36</b>
<b>3   OPERATING AND SAFETY PRECAUTIONS</b> .....	<b>9</b>	7.1 - Routine Inspection .....	36
3.1 - Safety Symbol Identification .....	9	7.2 - Tube Replacement .....	36
3.2 - Explanation Of Safety Signal Words .....	9	7.3 - Roller Assembly Replacement .....	38
3.3 - Product Parts Information .....	10	7.4 - Spare Parts .....	39
<b>4   INSTALLATION</b> .....	<b>11</b>	<b>8   TROUBLESHOOTING</b> .....	<b>42</b>
4.1 - Power Requirements .....	11	8.1 - Troubleshooting Guide .....	42
4.2 - Control Wiring .....	11	8.2 - Error Codes .....	44
4.2.1 - I/O Board .....	12	<b>9   AGENCY &amp; COMPLIANCE</b> .....	<b>45</b>
4.3 - Best Practices .....	13	<b>10   WARRANTY DECLARATION</b> .....	<b>46</b>
4.3 - Pre Operation Checklist .....	14	10.1 - Flush & Decontamination .....	46
<b>5   GETTING STARTED</b> .....	<b>15</b>		
5.1 - User Interface .....	15		
5.2 - Understanding the display (Home Screen) ..	15		
5.2.1 - Welcome screen .....	15		
5.3 - Keypad .....	16		
5.4 - Icons .....	17		
5.5 - Quick Start Guide .....	19		



# KML - SERIES

## Introduction

Thank you for purchasing an LMI KML Peristaltic Metering Pump. Items supplied vary according to product configuration. Make sure that the items supplied and the information on the nameplate correspond to the order confirmation. Check the individual packaging and the product visually for damage caused by inappropriate handling during shipment. Contact your distributor immediately if any items are missing or damaged.

For more information please visit [www.lmipumps.com](http://www.lmipumps.com)

### 1.1 | HOW TO USE THIS MAINTENANCE MANUAL

This manual is specific to LMI PUMPS KML series peristaltic pumps. It allows the users to install, to start and to carry out maintenance on these pumps. All persons, fitters and users must read this maintenance manual in its entirety. Documents concerning the gearbox, the electrical motors, as well as all other options (hose rupture detector, etc.) are provided in annex. Refer to the applicable section in this document to understand specific details regarding that component.

Your local LMI distributor can be contacted regarding information not contained in this manual. For a quicker reply, please provide the following information:

- » Pump Model Code
- » Pump serial number
- » Reference of order

### 1.2 | TRAINING OF THE USER AND INSTRUCTIONS

Every person who installs, uses or performs any operations of maintenance on the pump must be qualified and must have previously read this technical manual. Any temporary personnel must be supervised by skilled users. The order of execution of operations defined in this manual must be absolutely respected. Store this manual next to the pump so that it can be consulted at any time.

### 1.3 | HANDLING AND STORAGE

For best results, store this equipment with care according to these recommendations.

Pumps should not be placed in storage with tube element installed and under compression. Tube elements and accessories should be used within [two years] of date of manufacture. Store all pumps and accessories indoors in a dry environment with no exposure to UV light. Storage temperature: -40°C to 70°C (-40°F to 158°F).



**LMI**<sup>®</sup>

# KML - SERIES

## Introduction



### 1.4 | PUMP SPECIFICATIONS

Operating Temperature.....	-40°C - 50°C (14°F - 22°F)
Humidity.....	80% at 31°C, 50% at 40°C
Altitude.....	Max. 2000m (6560 ft)
Power Rating.....	KML2 [180W], KML3 [180W], KML4 [300W]
Power Required.....	110-230 VAC, 50-60 hz
Sound Level.....	<70 dB (A) at 1m
Maximum Flow Rate.....	KML2 - 17 gph / 65 lph KML3 - 34 gph / 130 lph KML4 - 160 gph / 608 lph
Maximum Pressure.....	Up to 7.6 bar (110 psi)
Speed Control.....	KML: 10,000:1
Motor Speed Range.....	0-100%
Weight	
KML2/KML3.....	35.6 lbs (16.1kgs)
KML4.....	72 lbs (32.6kgs)



### 1.5 | NAMEPLATE DETAILS

**MODEL # KML4-4-ACK1-1**

**SERIAL # 40124926411-02**

**POWER: 110-230 V 50/60 Hz 2.20 A**

**MAX FLOW: 55.5 GPH 210.0 LPH**

**MAX PRESSURE: 65 PSI 4.5 BAR**

**ASSEMBLED IN THE USA 201 IVYLAND RD IVYLAND PA 18974**

# LMI<sup>®</sup> KML - SERIES

## Introduction

### 1.6 | SERVICE POINT

Pumps are given a special QR code before shipping.

When maintenance is necessary, a plant engineer or technician uses a phone to scan the code, bringing up a list of replacement parts, service guidelines, a contact request, and other information.

You may obtain information about ordering spare parts, documentation, and manuals here.

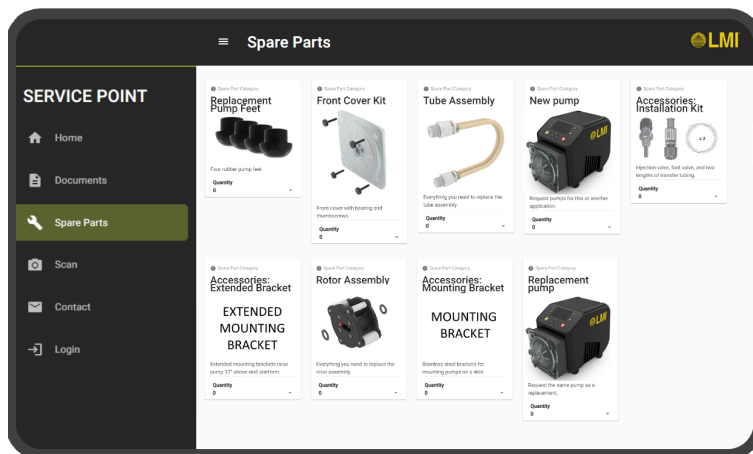
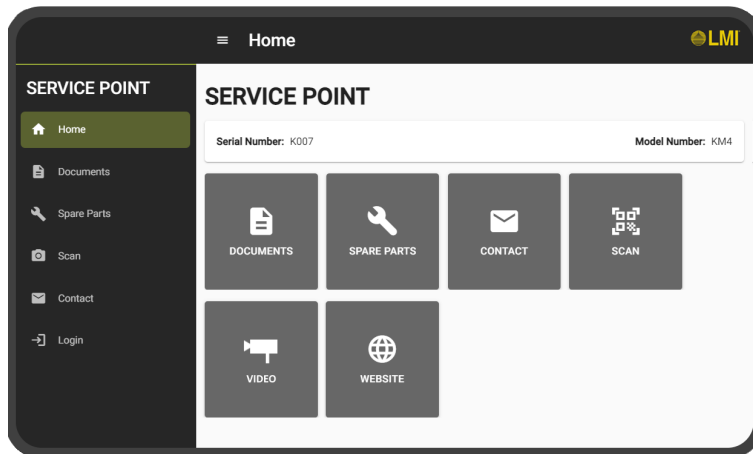



# KML - SERIES

## Model Description Chart

### 2.1 | MODEL CODE EXPLANATION

**Sample Part Number: KML2-4-ACG1-0**

K M L - 2 - 4 - A C G 1 - 0

<p><b>Series</b> KML</p> <p><b>Frame</b> 2 - Size 2 3 - Size 3 4 - Size 4</p> <p><b>Power Cord</b> 4 - US 115V 5 - US 230V 6 - EU 8 - Australia / New Zealand 9 - UK</p> <p><b>Connector</b> A - 1/2" NPT / BSPT (KML2 and KML3 include 3/8" tube compression fitting)</p> <p><b>Tube Material</b> A - XL Extended Life B - CR Chemical Resistant C - PT Petro-Tough</p> <p><b>Tube Detail - ID [in] and Count</b> Various Diameters</p> <p><b>Control Levels</b> 0 - Basic: Keypad control only 1 - SCADA: Speed control: 4-20 mA i/o Three contact inputs Four configurable relay outputs Frequency 2 - Advanced: Modbus TCP</p>	<p><b>No. of tubes</b> 1 - Single 2 - Double</p> <p><b>Tube Diameter</b> D - 0.075"    K - 0.375" E - 0.093" / 0.125"    L - 0.50" G - 0.187"    P - 0.75" H - 0.25"</p>
--	--

**NOTICE: All possible options are shown in section 2.4, however, certain combinations may not be recommended. Consult a representative or the factory if you have questions concerning availability.**

### TUBE ASSEMBLY CODE EXPLANATION

<p><b>Connector Type</b> A - 1/2" NPT / BSPT (KML2 and KML3 include 3/8" tube compression fitting)</p> <p><b>Tube Material Information</b> A - XL Extended Life B - CR Chemical Resistant C - PT Petro-Tough</p>	<p><b>No. of tubes</b> 1 - Single 2 - Double</p> <p><b>Tube Diameter</b> D - 0.075"    K - 0.375" E - 0.093" / 0.125"    L - 0.50" G - 0.187"    P - 0.75" H - 0.25"</p>
--	--



# KML - SERIES

## Model Description Chart

### 2.2 | MATERIALS OF CONSTRUCTION

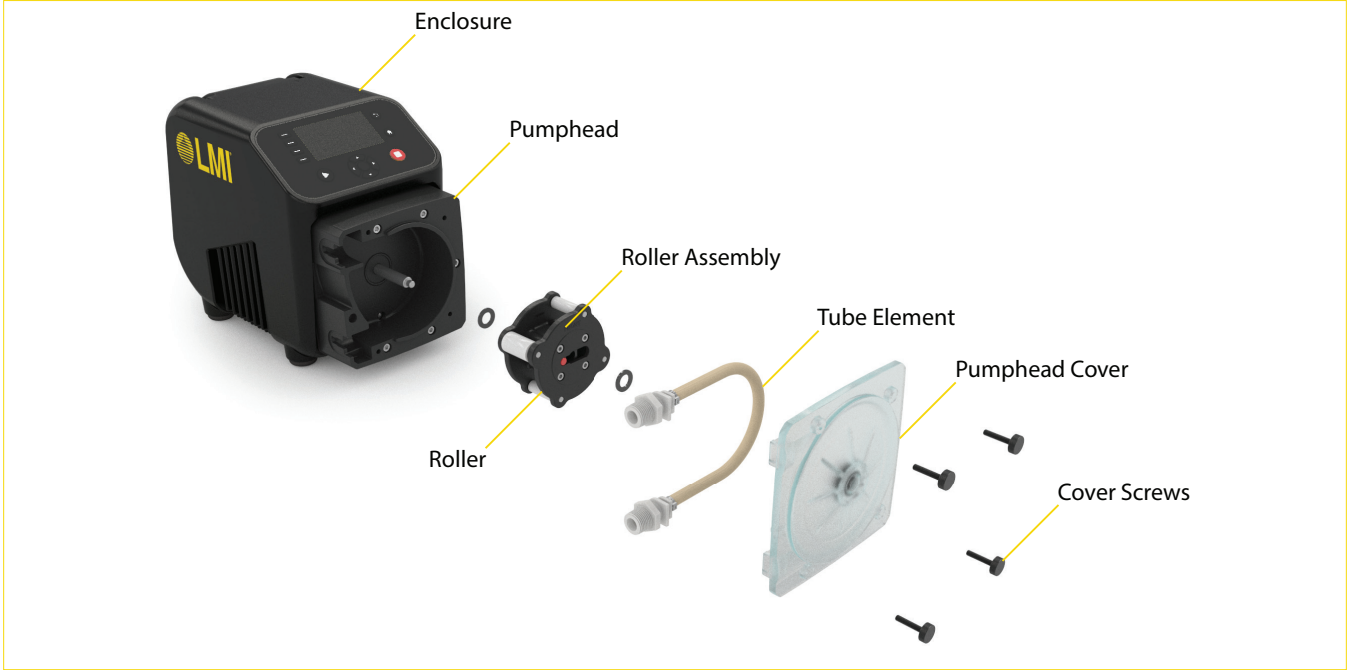

MATERIAL OF CONSTRUCTION	
ENCLOSURE	POWDER COATED ALUMINUM
PUMP HEAD	PBT THERMOPLASTIC
COVER	PLOYCARBONATE
ROTOR	PBT THERMOPLASTIC
ROLLERS	NYLON

MATERIAL OF CONSTRUCTION	
ROLLER BEARINGS	316 SS
ROLLER SHAFT	316 SS
MOTOR SHAFT	CHROME STEEL
COVER SCREWS	PLASTIC / 316 SS
TUBE CONNECTORS	PVDF

**LMI XL** - Extended Life tubing has excellent acid and alkali resistance, and is compatible with numerous oxidizing agents such as sodium hypochlorite. Tygon is best for fatigue life and is the longest-lasting tube in compatible applications. Min/max temperature: 0-80°C (32-176°F).

**LMI CR** - Chemical Resistant is suited for handling strong acids and bases, and is virtually unaffected by most commercial sanitizers & cleaners. Min/max temperature: 0-54°C (32-130°F).

**LMI PT** - Petro-Tough can be used with fats and oils, lubricants, and some solvents. Min/max temperature: 0-54°C (32-130°F).

# LMI<sup>®</sup> KML - SERIES

## Model Description Chart

### 2.4 | AVAILABLE TUBE ASSEMBLIES

	MATERIAL	PART #	GPH	L/H	PSI	BAR
KML2	XL	AAD1	1.7	6.5	100	6.9
		AAE2	4.4	16.8	110	7.6
		AAG2	17.1	65.1	110	7.6
	CR	ABH1	14.2	54	50	3.4
	PT	ACG1	9.3	35.2	65	4.5
		ACG2	14.9	56.7	65	4.5

	MATERIAL	PART #	GPH	L/H	PSI	BAR
KML4	XL	AAH1	28.4	108	100	6.9
		AAH2	53.7	204	100	6.9
		AAL1	99.5	378	50	3.4
		AAP1	158.5	600	30	2.1
	CR	ABK1	53.7	204	30	2.1
		ABK2	125.5	477	30	2.1
	PT	ACH1	39.5	150	65	4.5
		ACK1	55.3	210	65	4.5
		ACK2	99.5	378	65	4.5

Flow rates shown are at maximum pump speed.  
For best tube life, select a large tube and run the pump slowly.

	MATERIAL	PART #	GPH	L/H	PSI	BAR
KML3	XL	AAD1	2.1	7.9	100	6.9
		AAE2	4.7	18	100	6.9
		AAG2	18.9	72	110	7.6
		AAK1	33.2	126	100	6.9
		AAKL	33.2	126	30	2.1
	CR	ABK1	28.4	108	50	3.4
	PT	ACG1	10.1	38.4	65	4.5
		ACG2	18.2	69	65	4.5
		ACK1	28.4	108	65	4.5

### 2.5 | DIMENSIONS

mm (Inch)

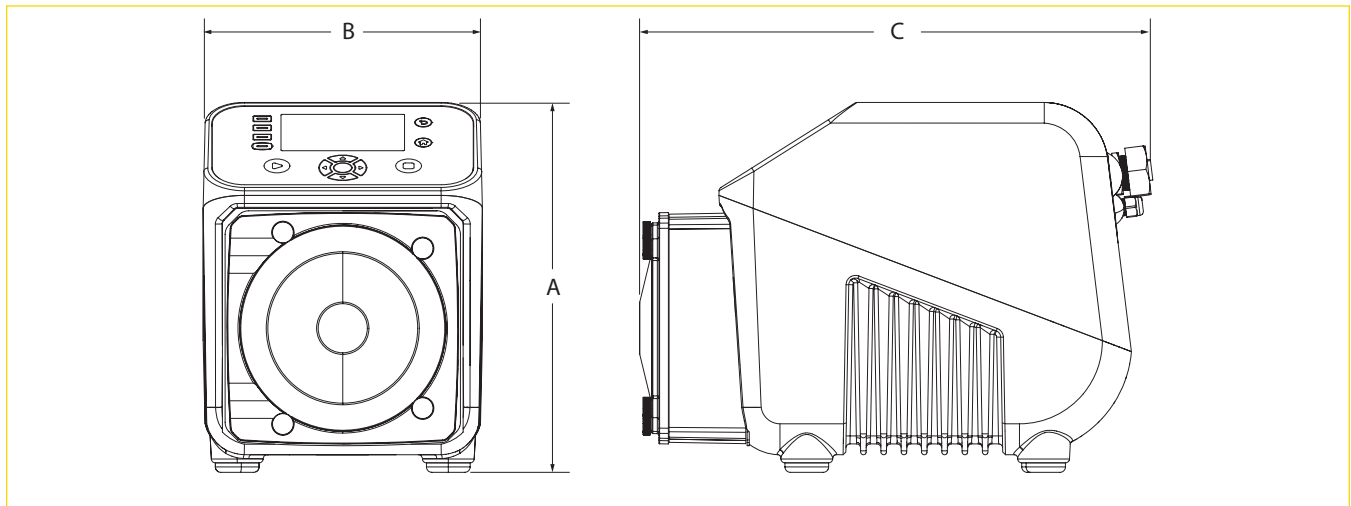

DIMENSION	KML2	KML3	KML4
A	246 (10.4)	246 (10.4)	363 (14.3)
B	206 (8.125)	206 (8.125)	308 (12.125)
C	361 (14.2)	361 (14.2)	455 (17.9)
Weight kg (lb)	35.6 (16.1)	35.6 (16.1)	72 (32.6)





# KML - SERIES

## Operating and Safety Precautions

### 3.1 | SAFETY SYMBOL IDENTIFICATION



Hot Surface



Do not scrub static  
spark Explosion  
Hazard



Crushing Hazard



Read Manuals  
Supplied  
With Product

### 3.2 | EXPLANATION OF SAFETY SIGNAL WORDS

**DANGER!** Indicates an imminently hazardous situation which, if not avoided, will result in death or serious injury.

**WARNING!** Indicates a potentially hazardous situation which, if not avoided, could result in death or serious injury.

**CAUTION!** Indicates a potentially hazardous situation which, if not avoided, may result in minor or moderate injury or property damage.

**NOTICE!** Indicates information or a company policy that relates directly or indirectly to the safety of personnel or protection of property.

For safety purposes, this equipment should only be used by appropriately-trained personnel after they have read and understood this manual, and accounted for any and all potential hazards. If the pump is used in a manner not recommended by LMI Pump, the warranty may be voided and risk to equipment and personnel could occur.

The following precautions should be taken when working with LMI Pumps. Please read this section carefully prior to installation.

**Protective Clothing:** ALWAYS wear protective clothing, face shield, safety glasses and gloves when working on or near your metering pump. Additional precautions should be taken depending on the solution being pumped. Refer to Safety Data Sheets (SDS) precautions from your solution supplier.

**Liquid Compatibility:** Determine if the materials of construction included in the liquid handling portion of your pump are adequate for the solution (chemical) to be pumped. Always refer to the solution supplier and the LMI Pump Chemical Resistance Chart for compatibility of your specific pump. Contact your local LMI Pump distributor for further information.

#### Electrical Connections:

**WARNING:** To reduce the risk of electrical shock, the metering pump must be plugged into a properly grounded grounding-type receptacle with ratings conforming to the data on the pump control panel. The pump must be connected to a good ground. Do not use adapters! All wiring must conform to local electrical codes. If the supply cord is damaged, it must be replaced by the manufacturer, stocking distributor, or authorized repair center in order to avoid a hazard.

#### Flooding:

**WARNING:** Install this pump in a location where flooding cannot occur.

#### Ground Fault Circuit Interrupter:

**WARNING:** To reduce the risk of electric shock, install only on a circuit protected by a Ground Fault Circuit Interrupter (GFCI).

**Line Depressurization:** To reduce the risk of chemical splash during disassembly or maintenance, all installations should be equipped with line depressurization capability.



# KML - SERIES

## Operating and Safety Precautions

**Over Pressure Protection:** To ensure safe operation of the pump it is recommended that some type of safety / pressure relief valve be installed to protect the piping and other system components from failing due to excessive pressure.

**Flow Display:** The accuracy of the flow value as shown on the pump display is highly dependent on the specific application. Calibration is necessary in order to display an accurate measure of the flow.

**Chemicals:** Safety procedures for hazardous fluids must be put in place to protect against injury to personnel. Operation of the pump after failure of the peristaltic tube can cause buildup of chemical in the pumphead. Some pumphead parts may not be compatible with certain aggressive chemicals. This can cause damage to the pumphead components, and pump internals if chemical spills are not promptly addressed.

**CAUTION:** Spills of Dangerous chemicals should be cleaned up immediately.

Lifting, transportation, installation, starting-up, maintenance and repair should be performed by qualified personnel only. The unit should be electrically isolated while work is being carried out. There is a replaceable fuse on the I/O Board.

### 3.3 | PRODUCT PARTS INFORMATION

**CAUTION!**

Only allow LMI PUMP trained technicians to perform maintenance on the products. For additional information contact LMI PUMP or nearest authorized distributor. The use of other than genuine LMI PUMP replacement parts may result in safety hazards, decreased pump performance and increased maintenance and will invalidate all warranties.

The original language of this manual is English. Other languages are a translation of the original manual. Manuals can be downloaded from [www.lmipumps.com](http://www.lmipumps.com)

Refer all communications to the nearest LMI PUMP Office or Distributor.

# LMI<sup>®</sup> KML - SERIES Installation

## 4.1 | POWER REQUIREMENTS

Electric shock is a real possibility with any electrical device. Grounding conductors and grounding-type attachment plugs are included with pumps. To reduce risk of electric shock, ensure that it is connected to a properly grounded receptacle.

Use correct supply voltage. Using incorrect voltage will damage pump and may result in injury.

Ensure that all electrical cable glands are placed and sealed appropriately. Never connect power and control cables together.

Equipment may start automatically. This pump has a user-selectable automatic restart capability that can either put the pump back in operation after a power outage or restart it completely.

If in doubt, contact a certified electrician.

## 4.2 | CONTROL WIRING



Remove the pump terminal box for access to the control terminals.

Conduit holes are 3/8" and 1/2". Use appropriate cable glands to ensure proper sealing is achieved.

For safety, do not apply 110-230VAC to control terminals. Signals applied to terminals must be within appropriate limits. Damage from misapplied signals can destroy the pump and is not covered under warranty.



# KML - SERIES

## Installation

### 4.2.1 | I/O BOARD

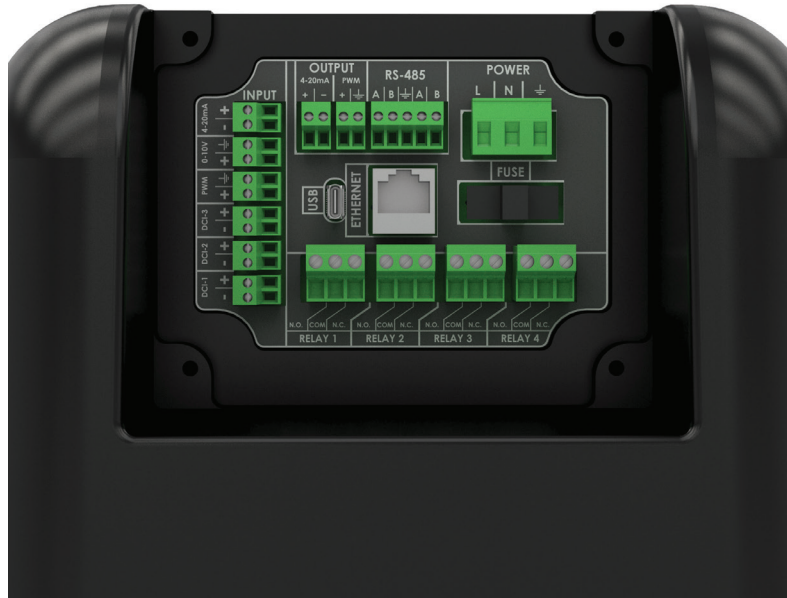

#### **INPUT:**

DCI-1 – Dry Contact Input for remote stop signal

DCI-2 – Dry Contact Input pump direction

DCI-3 – Dry Contact Input for start signal

PWM – Input for Frequency (10-2000Hz) control

0-10V – Analog speed control

4-20 mA – Analog speed control

#### **OUTPUT:**

4-20 mA – Analog speed feedback signal

PWM – Frequency (10-2000Hz) speed feedback signal

**RS-485:** RS-485 terminal for MODBUS RTU

**POWER:** 110-230 VAC input

**USB:** USB-C interface for uploading software and downloading log files

**ETHERNET:** Ethernet cable port for industrial protocol communications

**FUSE:** Fuse compartment with replaceable 6.3A 250V AC/DC Fuse Cartridge, 5mm x 20mm (Equivalent to Bel Fuse Inc. 5ST 6.3R)

**RELAYS:** 4 configurable digital form-C relays



**LMI**<sup>®</sup>

# KML - SERIES

## Installation



### 4.3 | BEST PRACTICES

Peristaltic pumps are self-priming and do not allow backflow up to rated pressure. No valves are required in inlet or discharge line, however may be useful in some circumstances:

- » In case of a pumphead or tube failure, users can install a check valve between the pump and the discharge pipework to prevent pressurised fluid from backflowing.
- » Any valves in the process flow must be open before starting the pump. Include a pressure relief device in the discharge line prior to any valves to protect against damage caused by accidental operation against a closed valve.

**Tube selection:** Refer to the LMI Pump website for a chemical compatibility guide. For help with compatibility issues, contact a distributor or LMI Pump customer care.

In normal operation, the pump rotates in a counter-clockwise direction and the ports are left-facing. In this configuration, the bottom port is used for suction, and the top port is used for discharge. However, pump has no impact on performance if the pump is configured to run in either direction.

Install the pump on a stable and level horizontal surface. Pump is equipped with rubber feet, however if desired, the pump includes threaded holes on the bottom that could be used to bolt the pump in place. In order to allow the pump to dissipate heat, ventilation is crucial. Keep dirt and dust out of the pump enclosure.

Ambient temperature (surrounding temperature) should be within the recommended limits.

Do not stack pumps.

Keep the pipes for suction and discharge as short and straight as possible.

Use bends with a big radius, at least four times the tube diameter.

Use of suction pipe or tube with a bore smaller than the pump tube bore should be avoided.

Connect the pump to the hard pipe using a flexible tubing portion to reduce any pulsation and make it easier to access the pumphead.

The pump can lift 10 feet or more of suction depending on which tube is installed. For maximum performance and longest tube life, a slightly flooded suction is recommended.

After changing a tube or any application or process, calibrate the pump. To keep accuracy, calibrate on a regular basis.

When pumping viscous fluids:

- » Use tubes or pipes several times larger than the pump tube for suction and discharge.
- » Run the pump slowly.
- » Maximize NPSHa



# LMI® KML - SERIES

## Installation

### 4.4 | PRE OPERATION CHECK LIST

CHECK LIST	
Pumps have been completely installed in their final location, piping has been connected, and motors are energized to allow running of the pumps.	
Proper electrical voltage is supplied and connected to pumps and controls	
Remote signal amperage and voltage is within pump limits.	
Pumps are freely accessible from all sides.	
Sufficient space is available to perform maintenance.	
Pumps are mounted on a clean, level platform.	
Pumps are stable.	
Pipework design is optimal for pump performance.	
Accessories are correctly installed.	
Flange covers/dust covers and caps are removed.	
Appropriate valves are open.	



# KML - SERIES

## Getting Started

### 5.1 | USER INTERFACE

A User interface is the Point of User -System interaction and communication on a device. This included Display screen and Keypad. User interface enables users to effectively control the device they are interacting with.

### 5.2 | UNDERSTANDING THE DISPLAY

#### 5.2.1 | HOME SCREEN

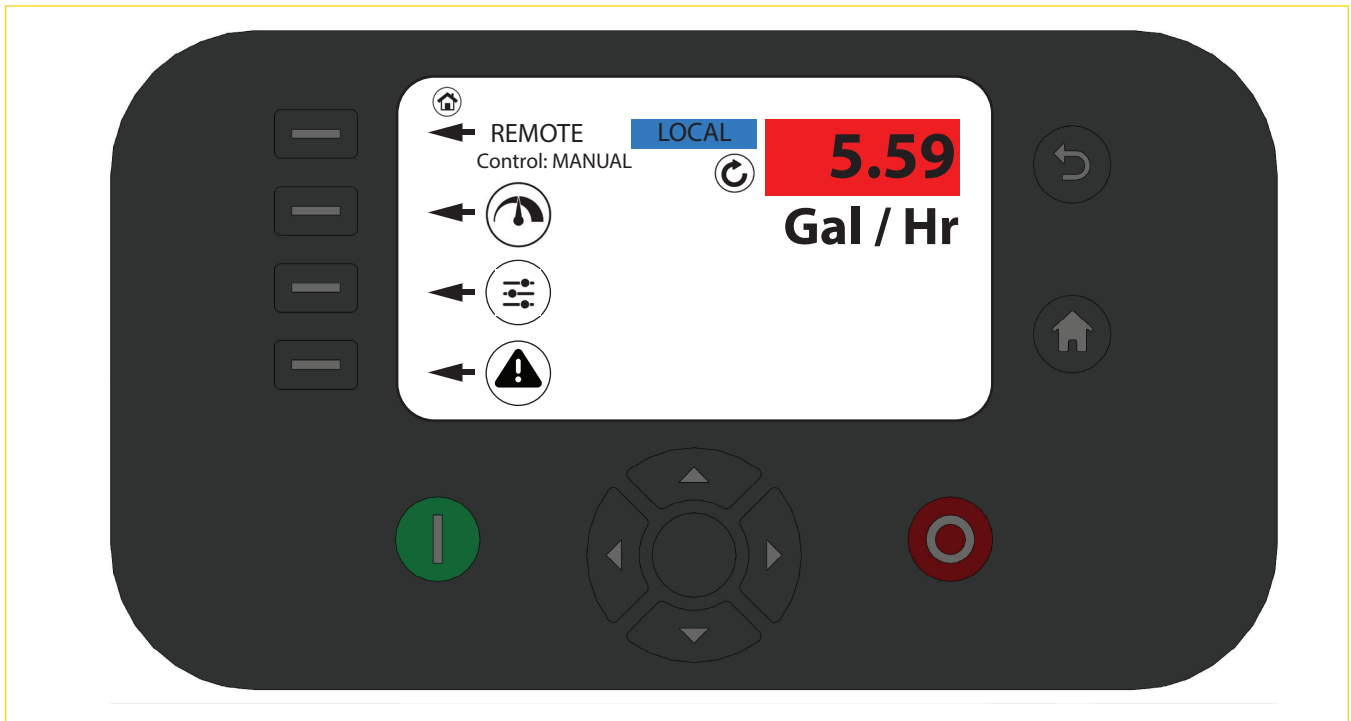

- ① Displays where control of pump is located (i.e. if pump is locally controlled, all network control is disabled. Remote control allows control from network or local).
- ② Current Pump Speed:
  - » Units displayed according to Menu options.
  - » Zero Speed is displayed as 0, Stop is displayed as 0 with Red background.
- ③ Units displayed here are what is selected in the Display Settings Screen.

### 5.3 | KEYPAD

LMI KML-Series pumps are equipped with a 13-button keypad and color display.

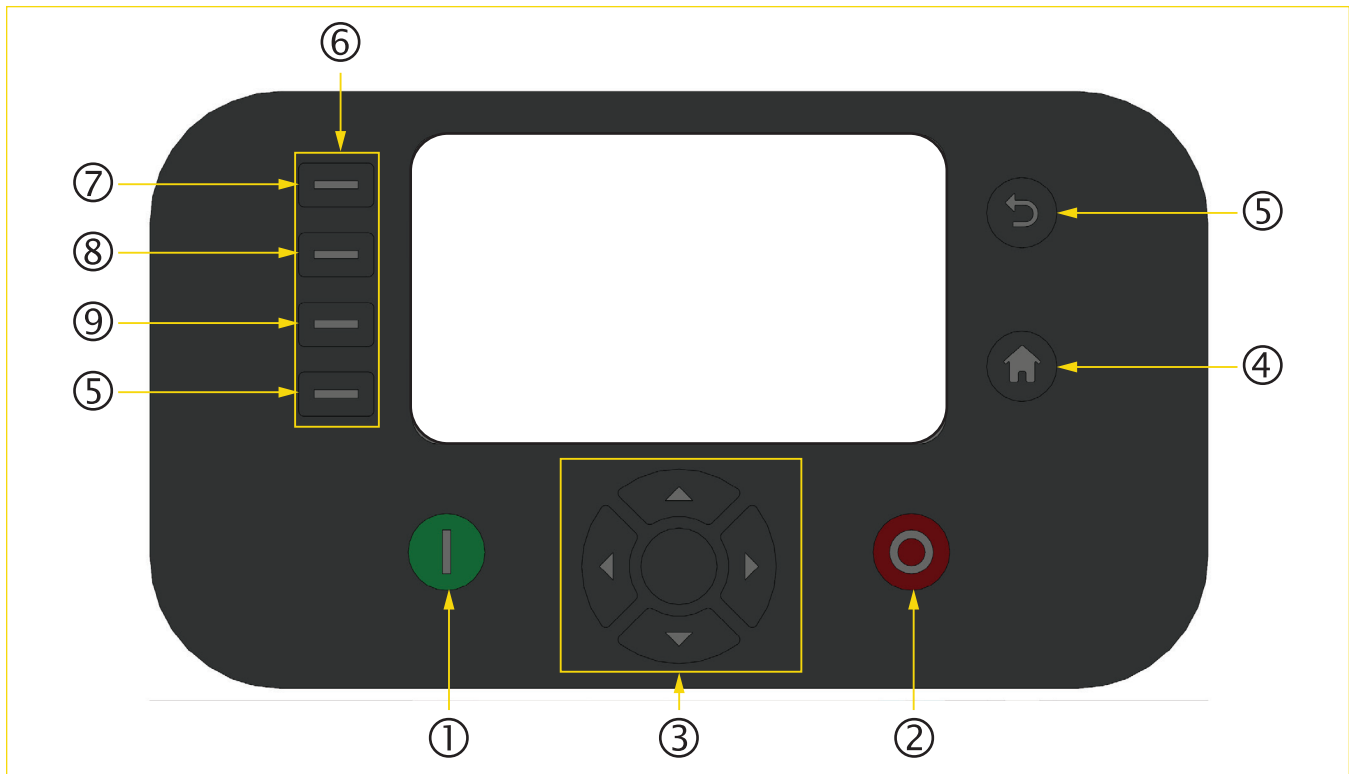

- ① **RUN Button**
  - » When pump is OFF, press and hold to turn pump ON.
  - » From Home screen, press to start pump. Press and hold to prime the pump.
- ② **STOP Button:**
  - » Press to stop pump.
  - » Press and hold to turn pump OFF.
- ③ **NAVIGATION Buttons (Up and down cycle through menu items):**
  - » Center button selects highlighted menu item. Also accepts value entered. In situations where user is in editing mode, pressing the center button, accepts value.
  - » When adjusting pump speed or other quantity, press of left or right to highlight the first digit. Additional presses move the cursor to adjacent digits. Up and down adjust the value, and select accepts the value.
- ④ **HOME Button**
  - » Always returns to home screen. Edited data is saved.
  - » From Home screen, press to start pump. Press and hold to prime the pump.
- ⑤ **RETURN / ESCAPE Button :**
  - » Always returns to previous screen/previous mode (i.e. exiting editing mode)
  - » Only accepted values are stored (through center button press). If center button was not pressed prior, previous value is valid.
- ⑥ **SOFT Buttons:**
  - » Use to select the menu item to the right that currently being displayed.
- ⑦ **LOC/REM toggles between local and remote control from home screen.**
- ⑧ **Adjust pump speed from home screen**
- ⑨ **Go to Settings screen from home screen**
- ⑩ **More options (offers batch/dose mode and lock) from home screen**











# KML - SERIES

## Getting Started



### 5.4 | ICONS

ICON	NAME	FUNCTION
	Pump Speed	Adjust pump speed in manual mode
	Settings	Settings menu contains access to system menu, tube settings, calibration, communications, and log files
	System	Adjust display settings, languages, display units, password and security, auto restart, and about information
	Tube Settings	Tube settings options
	Calibration	Enter calibration mode
	I/O Settings	Select remote control modes, i.e., SCADA, Pulse, and industrial protocols
	About	View serial number and upgrade software
	Log	View and download pump operating history



# KML - SERIES

## Getting Started

ICON	NAME	FUNCTION
	Lock	Enables passcode security
	Rotation direction CCW	Direction setting is counterclockwise
	Rotation direction CW	Direction setting is clockwise

# LMI<sup>®</sup> KML - SERIES

## Getting Started

### 5.5 | QUICK START GUIDE

#### 5.5.1 | SETTINGS SCREEN

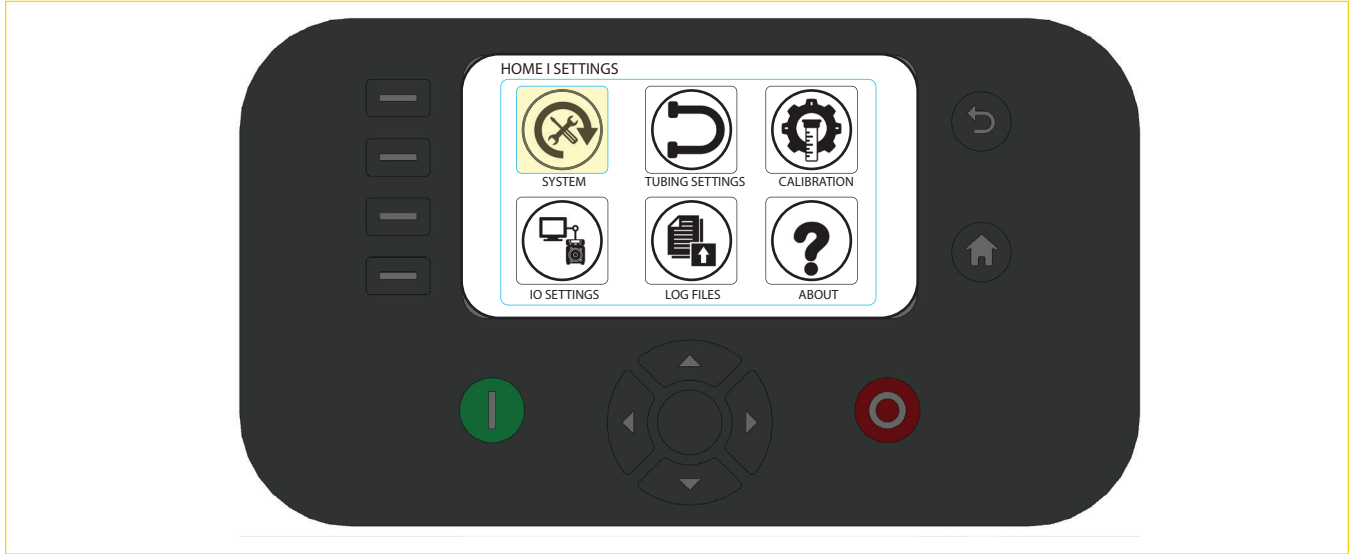

#### 5.5.1.1 | SYSTEM SCREEN



Selecting the System menu offers the following options:

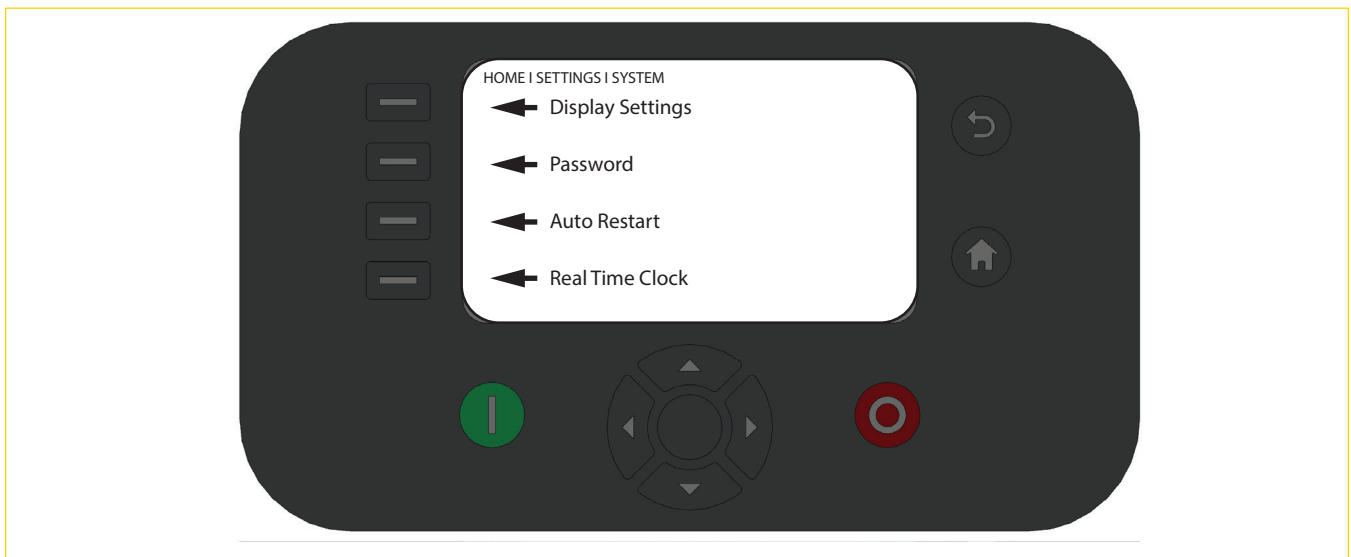



# KML - SERIES

## Getting Started



### SYSTEM - DISPLAY SETTINGS:

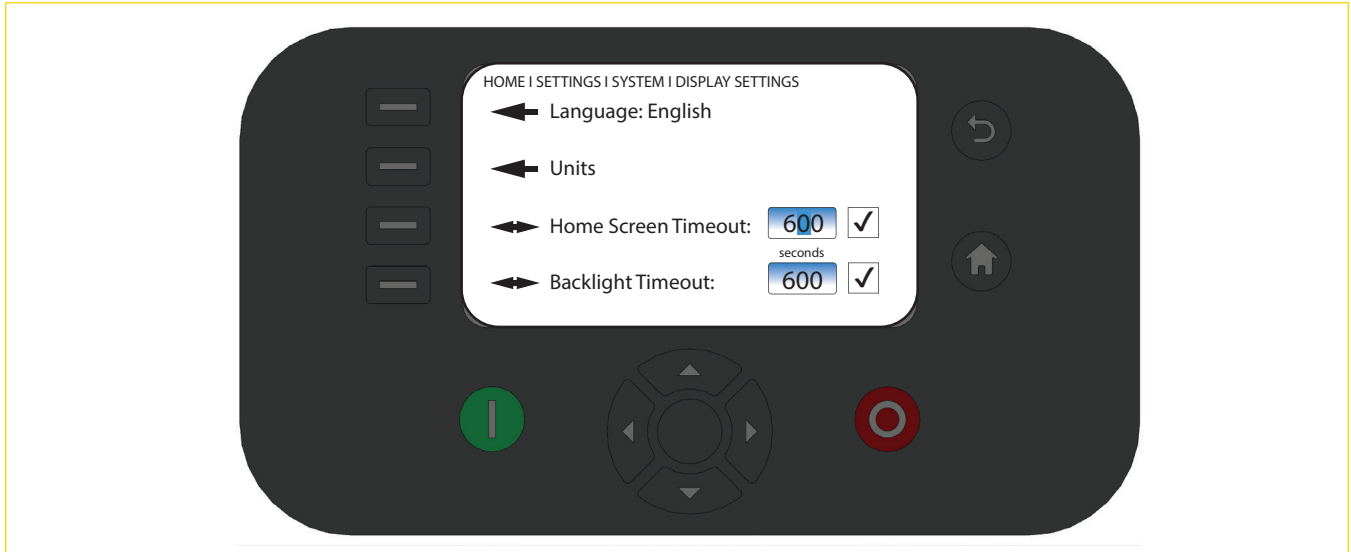

### SYSTEM - DISPLAY SETTINGS - LANGUAGE:





# KML - SERIES

## Getting Started



### SYSTEM - DISPLAY SETTINGS - UNITS

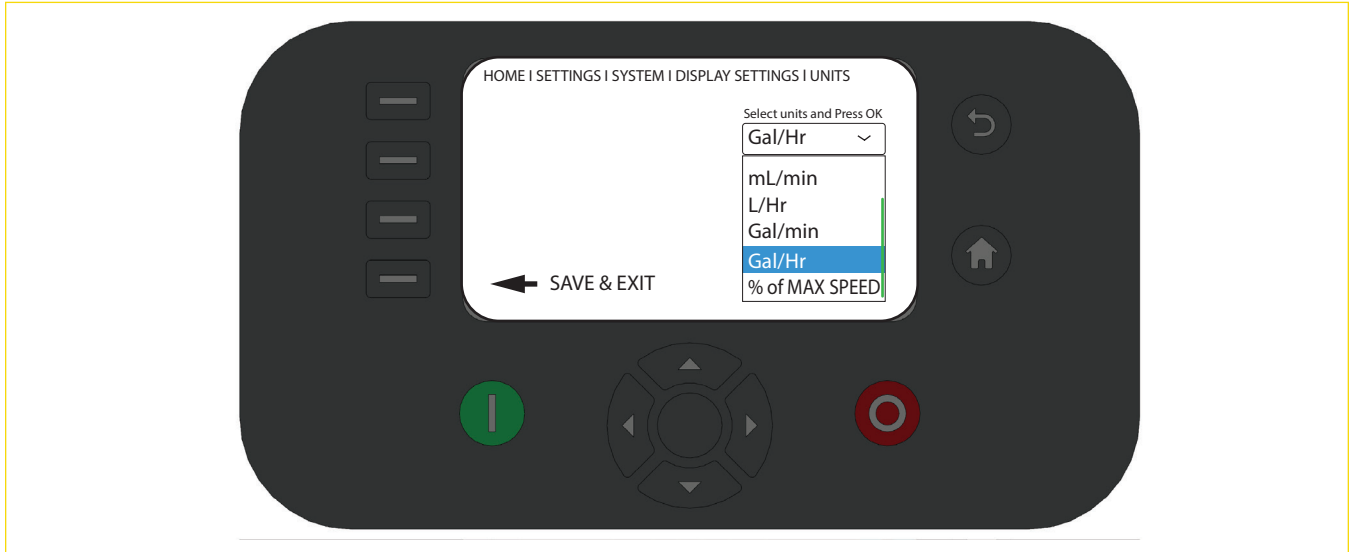

### SYSTEM - DISPLAY SETTINGS - HOME SCREEN TIMEOUT AND BACKLIGHT:

Use soft buttons to select Home Screen or Backlight Timeout. Use navigation buttons to adjust values. Press SELECT to save.

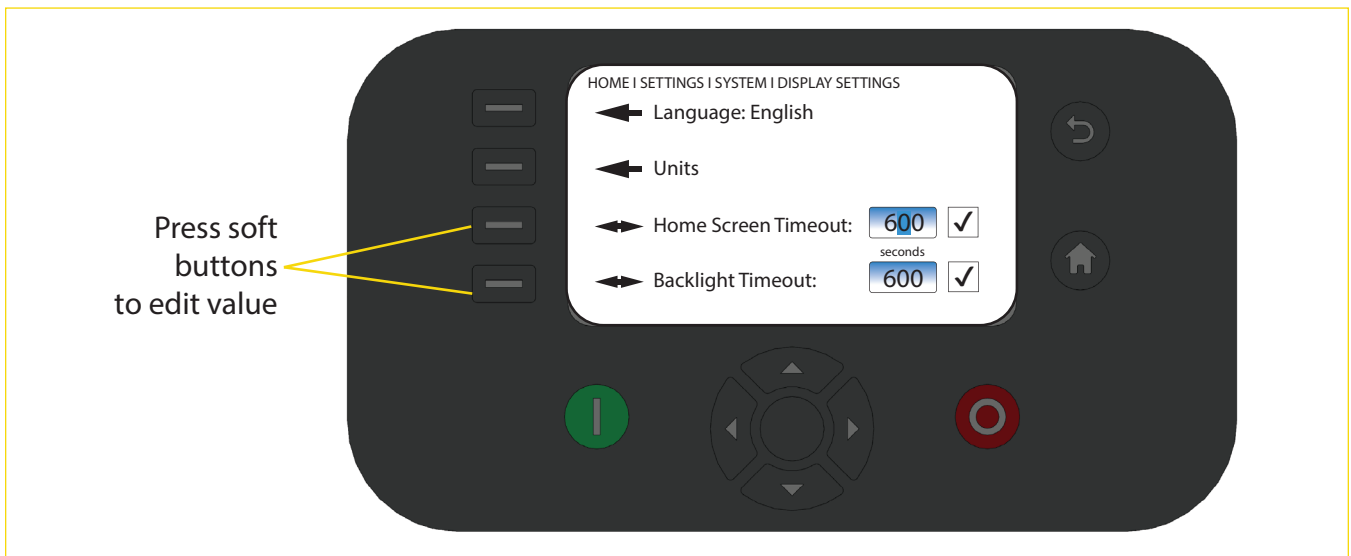



# KML - SERIES

## Getting Started



### SYSTEM - AUTO-RESTART

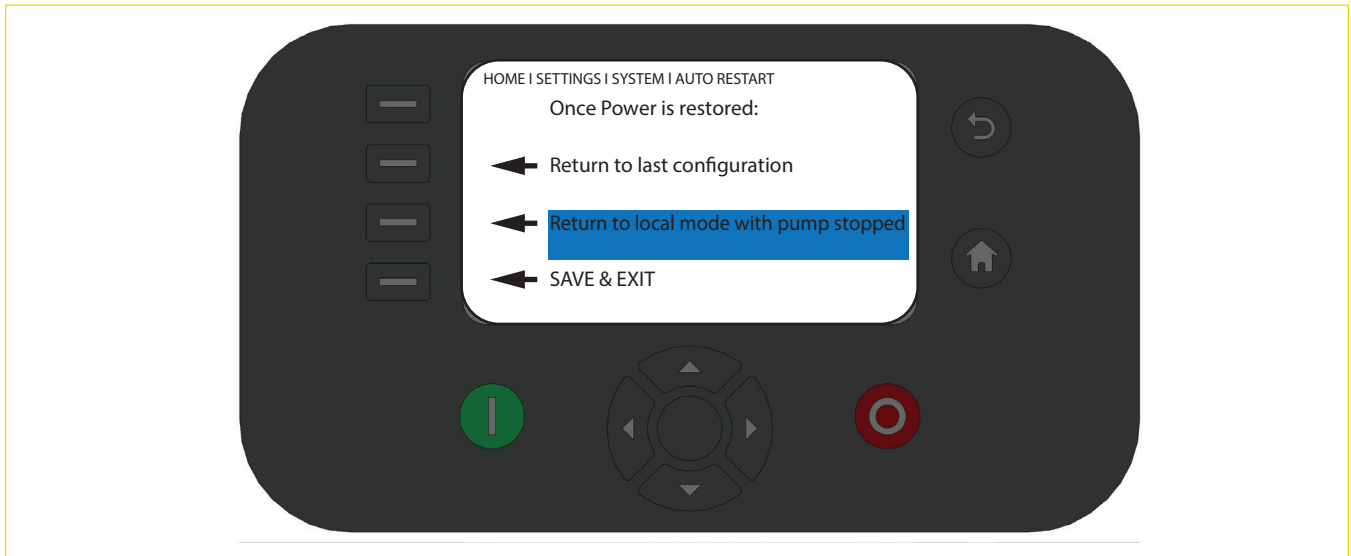

### 5.5.2 | TUBE CHANGE SCREEN

Tube change screen under settings menu gives users two options: install new tube element or view and edit maintenance interval settings.

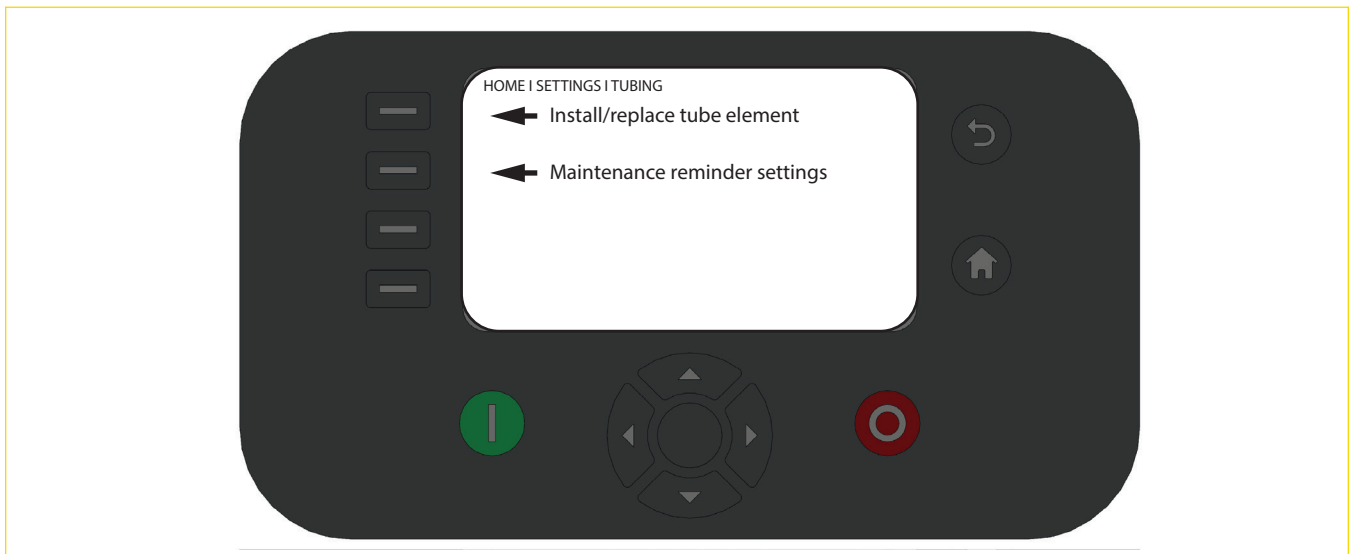

Press the soft button for Install new tube element to enter maintenance mode.



# KML - SERIES

## Getting Started



### TUBE CHANGE – INSTALL NEW TUBE ELEMENT

The pump will display brief instructions for the tube change procedure. For complete instructions including safety protocols see Section 7.0 Maintenance, follow the on-screen prompts, or scan the pump QR code to access a tube change maintenance video online.

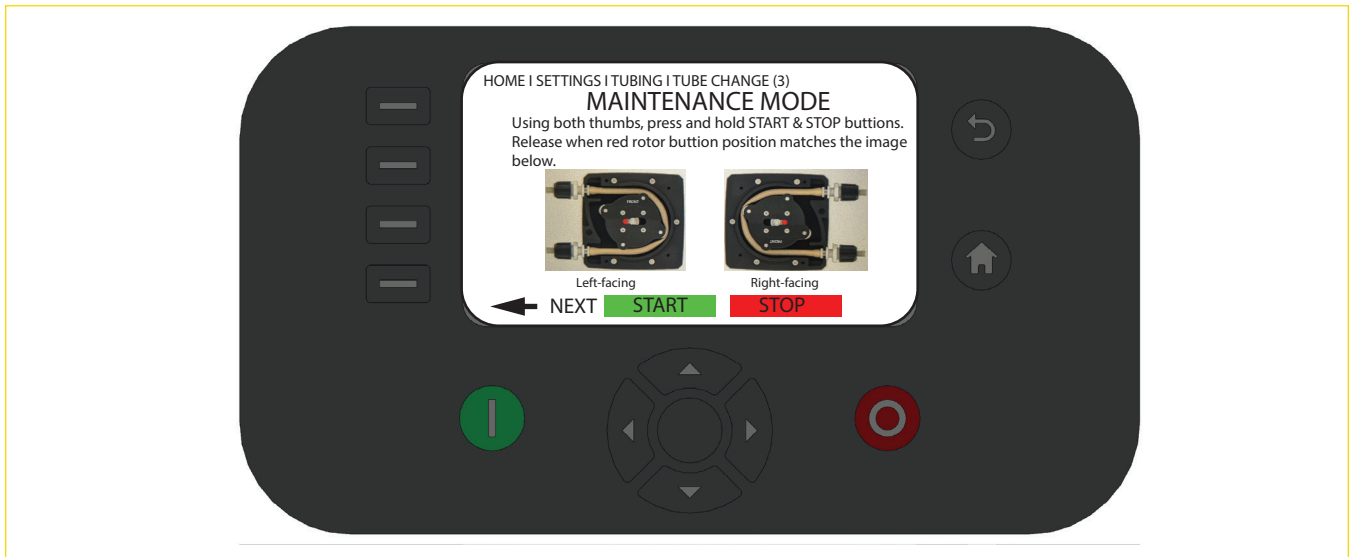

Press NEXT to continue

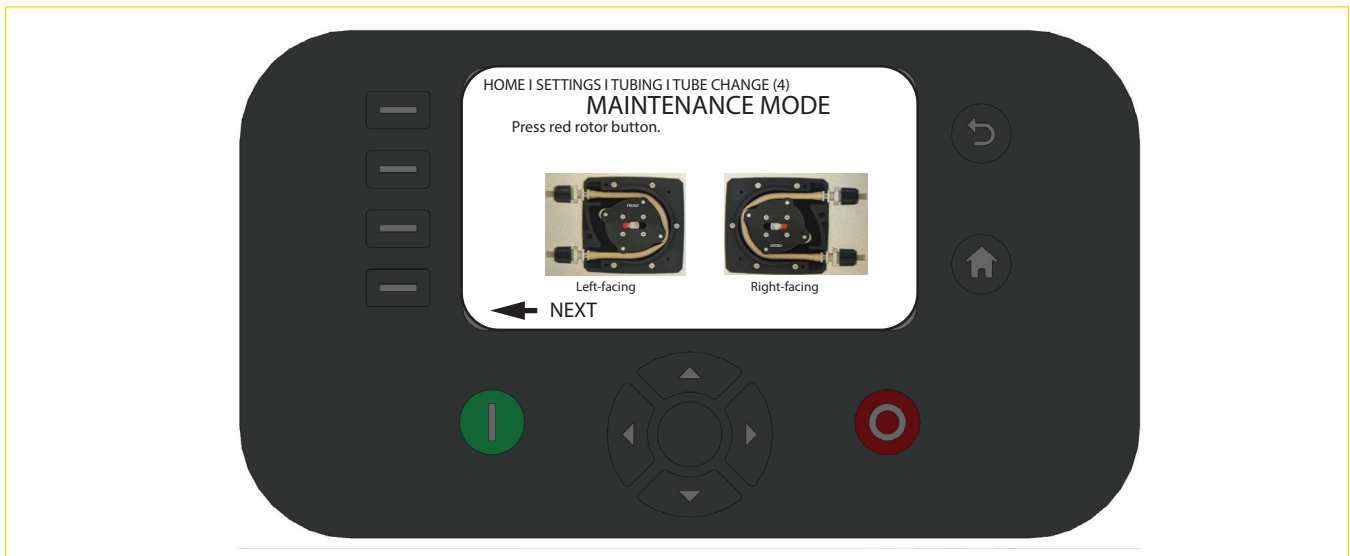

Press NEXT to continue

# LMI® KML - SERIES

## Getting Started

### TUBE CHANGE – INSTALL NEW TUBE ELEMENT

The tube change is now complete. It is recommended to calibrate the pump after a new tube is installed, and reset the maintenance interval counter if desired.

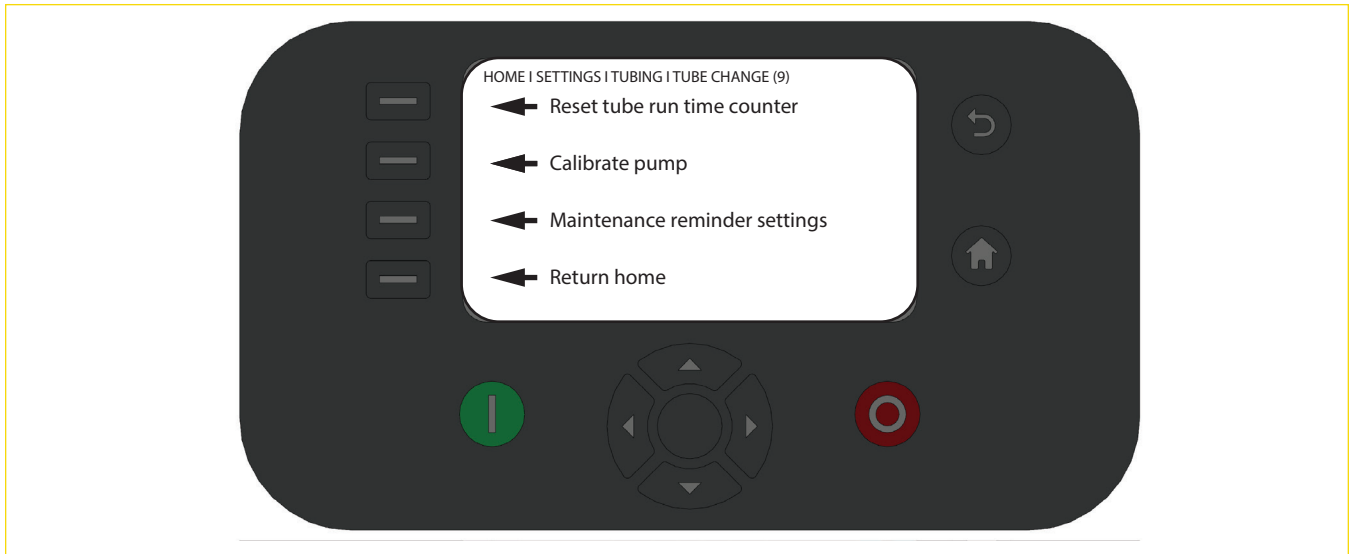

### TUBE CHANGE – MAINTENANCE INTERVAL SETTINGS

The Maintenance Interval function enables the pump to generate a warning on the Home screen to alert the user that a pre-programmed number of run hours is approaching. This reminder will help avoid unplanned maintenance.

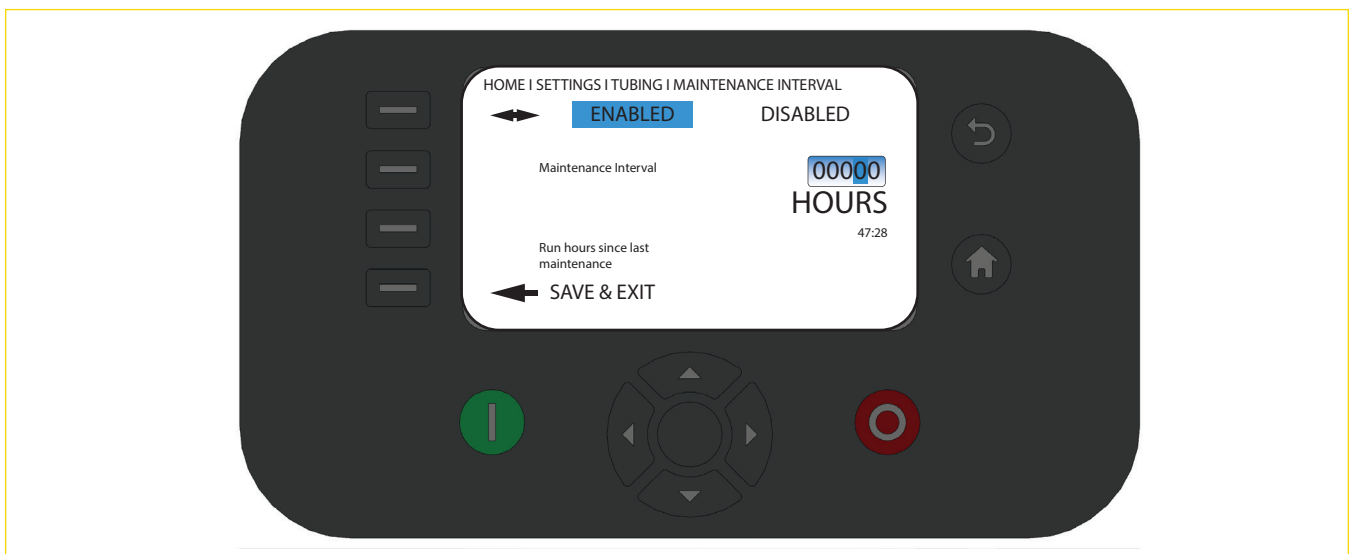



# LMI<sup>®</sup> KML - SERIES

## Getting Started



### SETTINGS – TUBE CHANGE – MAINTENANCE INTERVAL SETTINGS

Once 90% of the maintenance interval has passed, the pump will display a notice on the home screen:

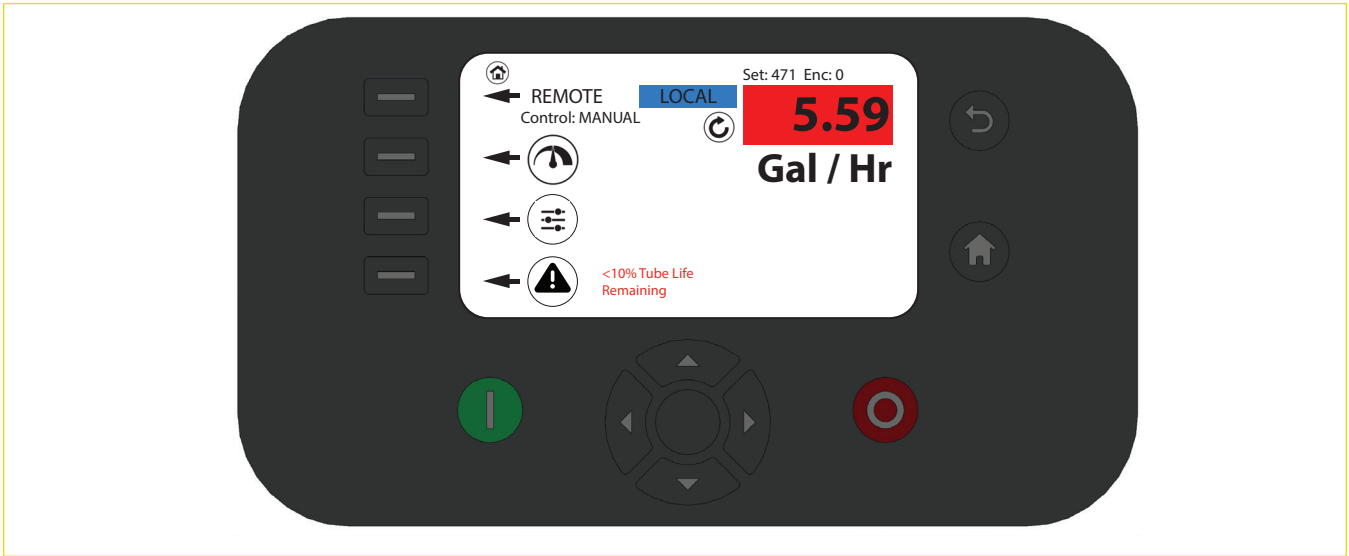

# LMI<sup>®</sup> KML - SERIES

## Getting Started

### 5.5.3 | CALIBRATION SCREEN



#### CALIBRATION SCREEN - CALIBRATION PROCEDURE

- » Enter Calibration Mode
- » Press start button. Pump will run for 30 seconds.
- » Pump will ask user to input volume pumped in mL
- » Input volume and press [save] **NOTE:** Resetting Factory Calibration will reset pump flow rate to initial tubeset default provided with pump.

TIP: Pump calibration will run at the current speed setup in manual mode. For best results, calibrate the pump at a speed where the pump would typically operate. Pump will not calibrate at zero speed.

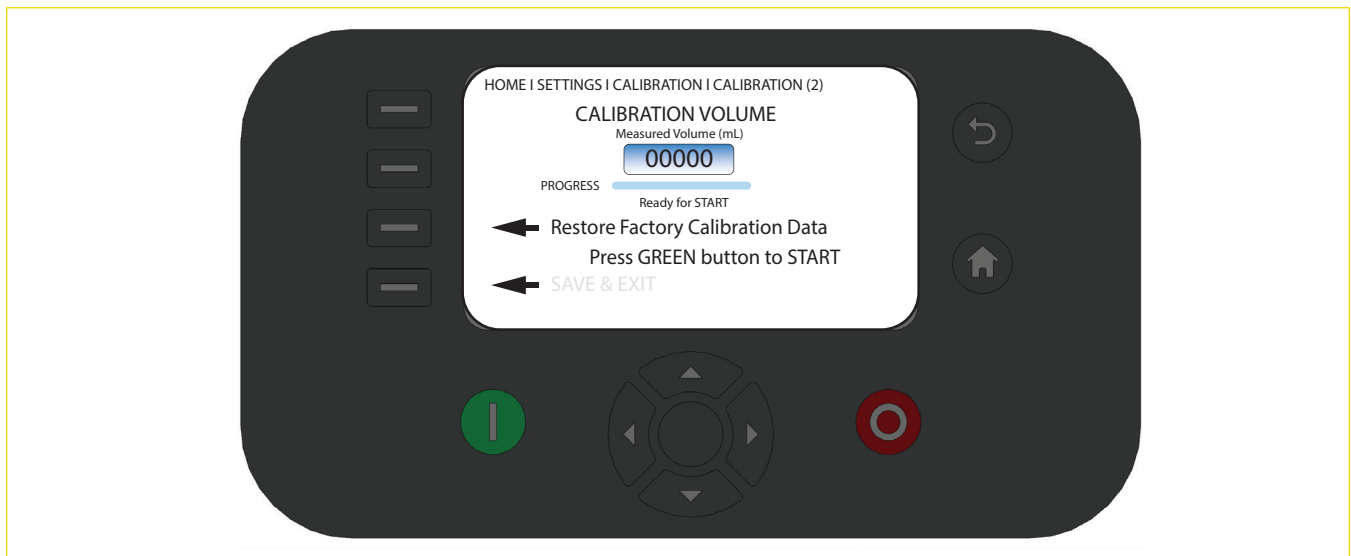

# LMI<sup>®</sup> KML - SERIES

## Getting Started

### 5.5.4 | I/O SETTINGS



#### I/O SETTINGS SCREEN

Select an option to modify parameters. Active I/O method is highlighted.

NOTE: The highlighted option is what the pump will automatically switch to when the LOCAL/REMOTE button is pressed from the home screen.

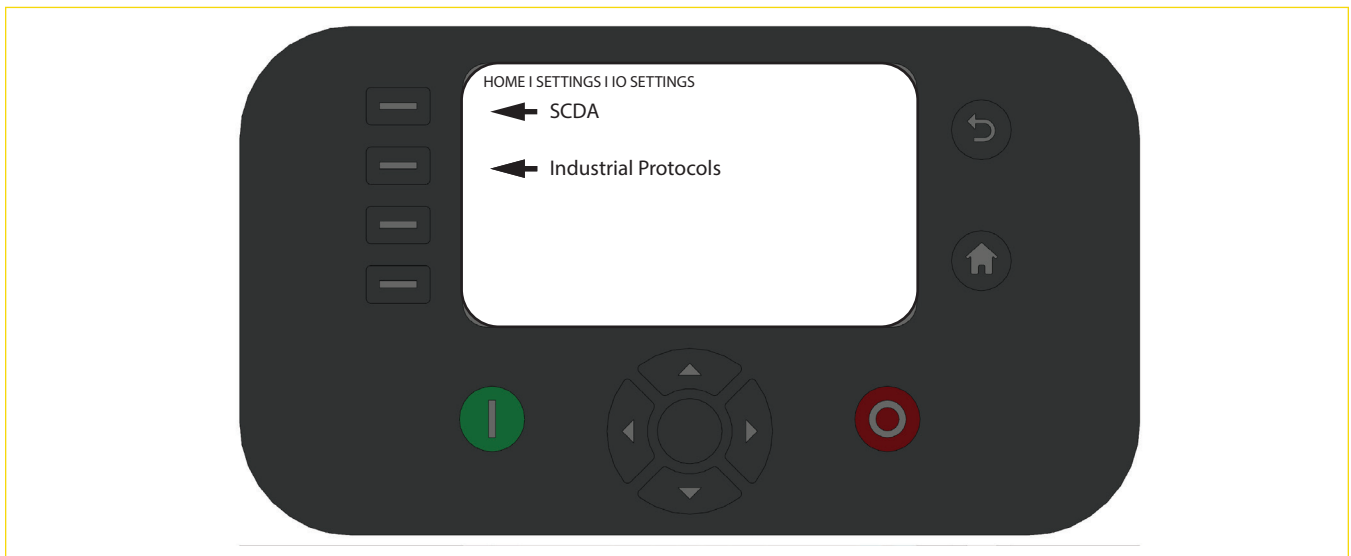

SCADA includes analog speed control, input contacts and speed feedback outputs.

Industrial Protocols includes Modbus RTU and Modbus TCP/IP.

Section 6.0 contains setup instructions for each I/O protocol.

# LMI<sup>®</sup> KML - SERIES

## Getting Started

### 5.5.5 | LOG



### LOG SCREEN

Use this screen to export logged events to USB.

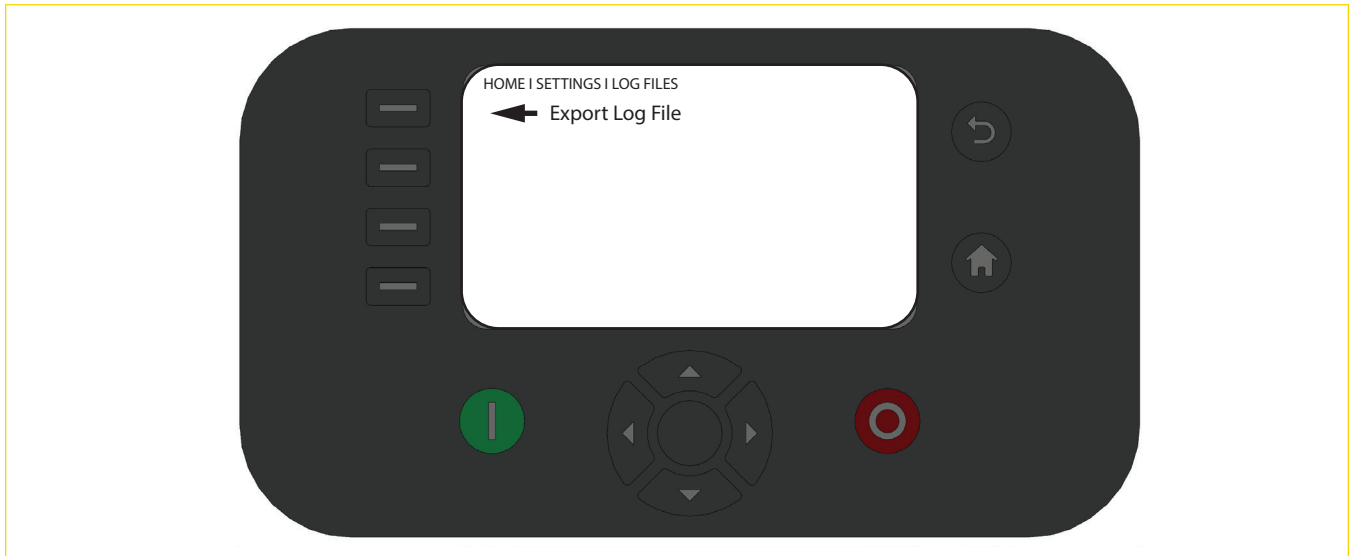

View alarms, warnings, and logged events on-screen by selecting the information icon from the home screen.

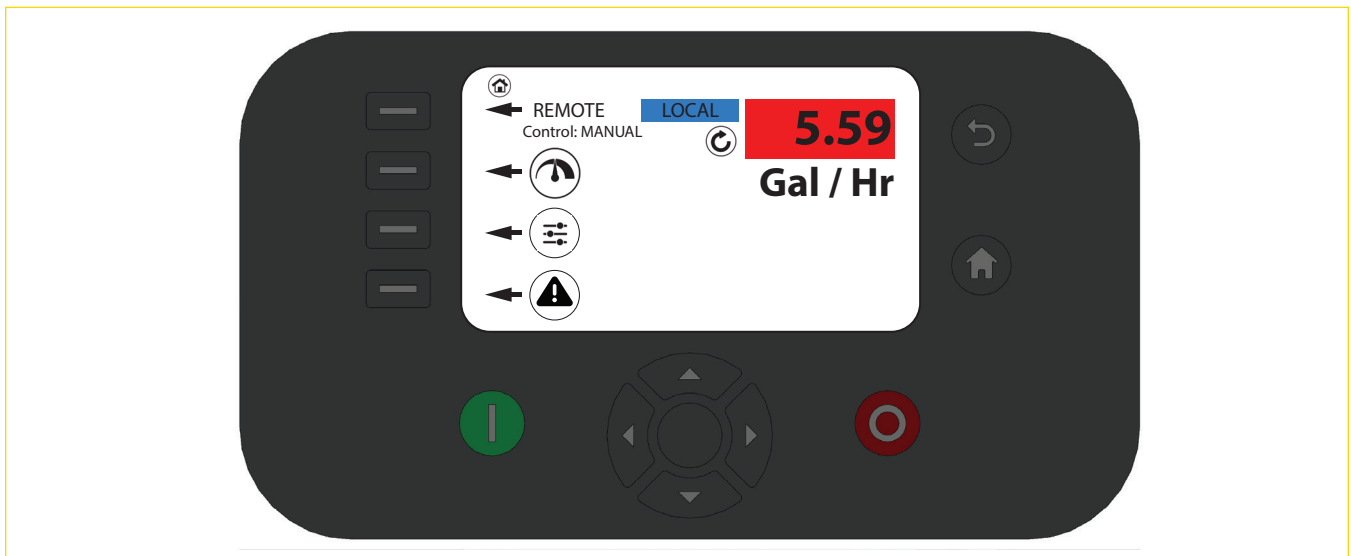



# KML - SERIES

## Getting Started

### 5.5.6 | ABOUT



#### ABOUT SCREEN

Use this screen to display pump serial number. This screen is also used for firmware updates and communications upgrades.

Contact your distributor or [www.lmipumps.com](http://www.lmipumps.com) for questions regarding firmware updates and communication upgrades..

For communication upgrades, once provided an upgrade code, use navigation buttons to input code and press Select.

For firmware updates insert USB with provided update file and press Select. Pump will automatically reboot after installation

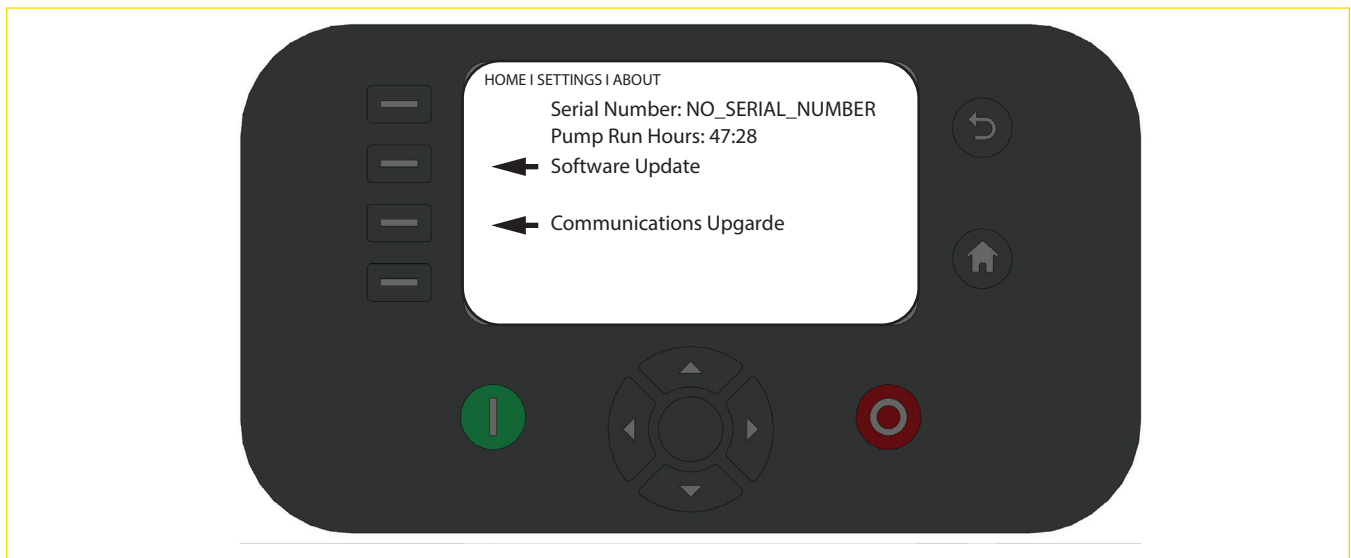

# LMI<sup>®</sup> KML - SERIES

## Operating Modes

### 6.1 | MANUAL MODE

In manual mode, also called local mode, the pump is looking for speed, direction, and start/stop command at the keypad only. The pump will not accept any remote inputs other than remote stop (E-stop) while in Manual mode.

Press 'Pump Speed' soft button then use navigation buttons to adjust speed. Press center navigation button to save.

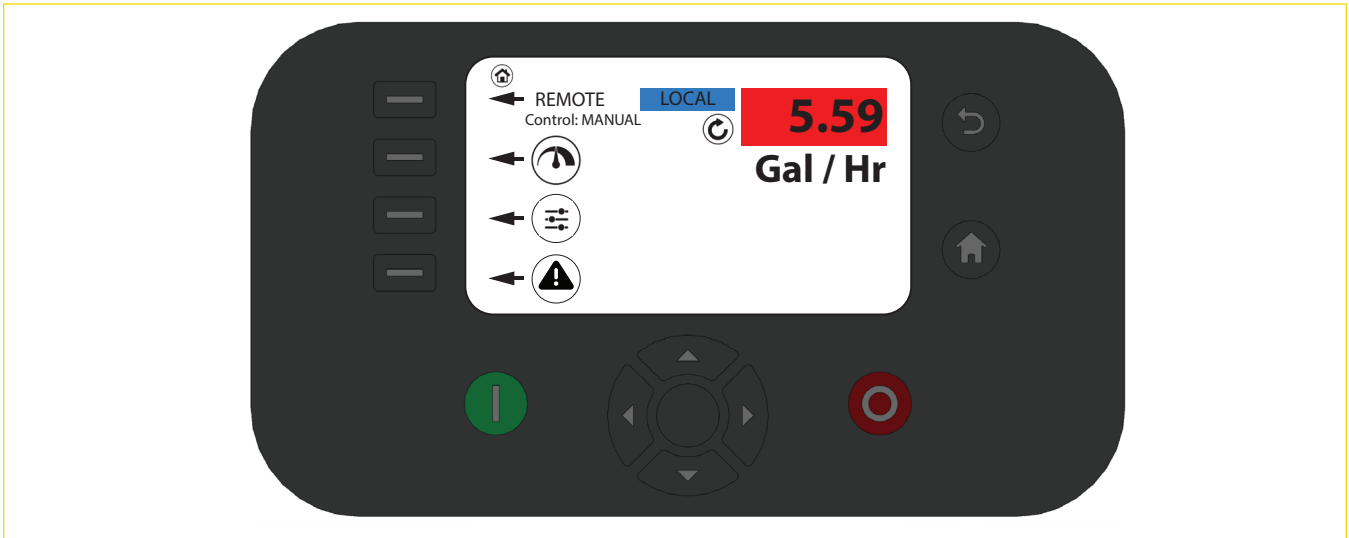

### 6.2 | REMOTE MODE

#### 6.2.1 | SCADA

#### 4-20 mA, 0-10VDC or Frequency (PWM)

Select SCADA from I/O Settings Screen shown in 5.5.4 .

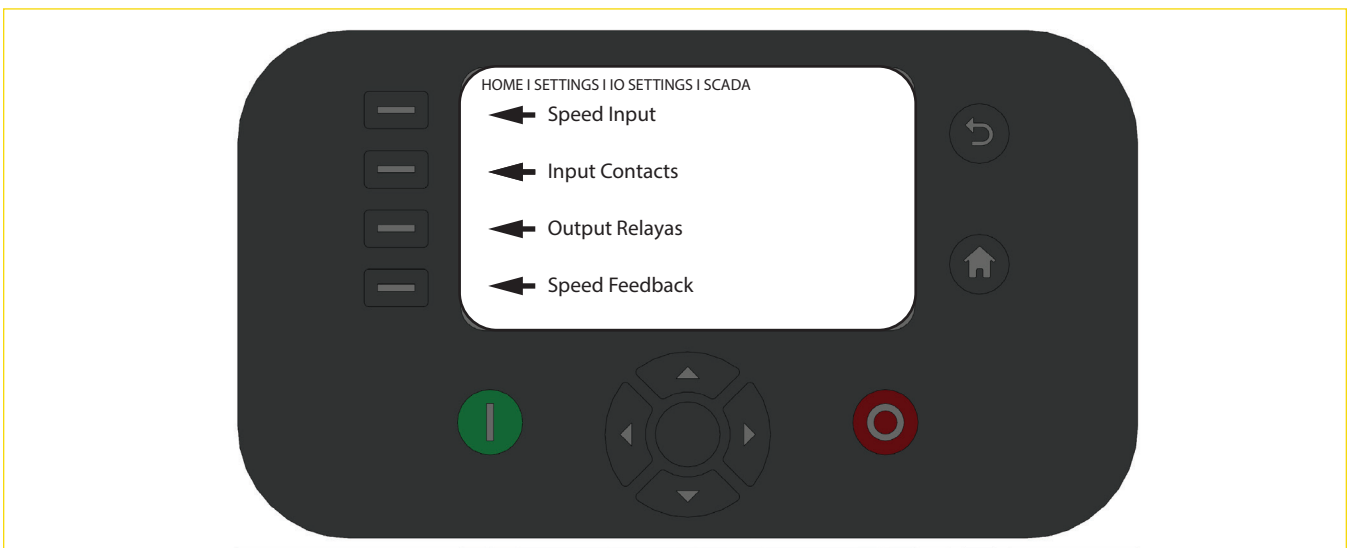



# KML - SERIES

## Operating Modes

The pump can be configured to accept an analog signal for speed control. The pump can also scale the signal as needed. Speed input displays the scaled value for pump operation according to the incoming signal value.

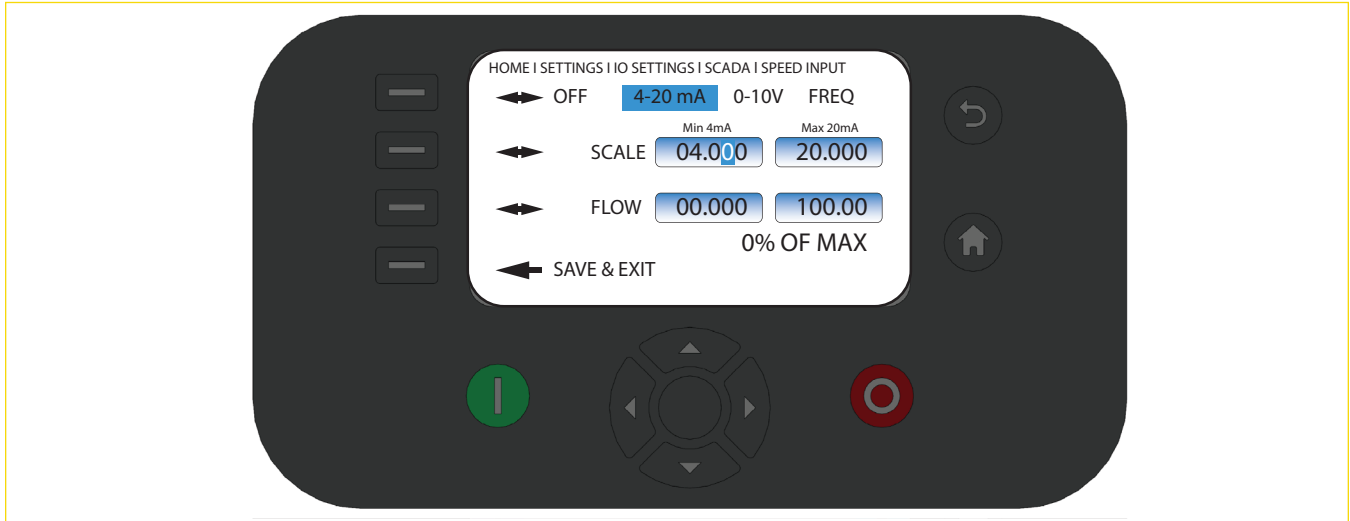

### Digital inputs (dry contact):

- » Start/stop (**NOTE:** Using SCADA mode requires the use of the Start/Stop Contact. If none will be implemented, selecting NC (Normally Closed) will keep the contact always in a 'Start' mode)
- » Direction
- » Remote stop - Allows pump to be stopped by an appurtenance such as a pressure switch, level switch, or an emergency stop button.

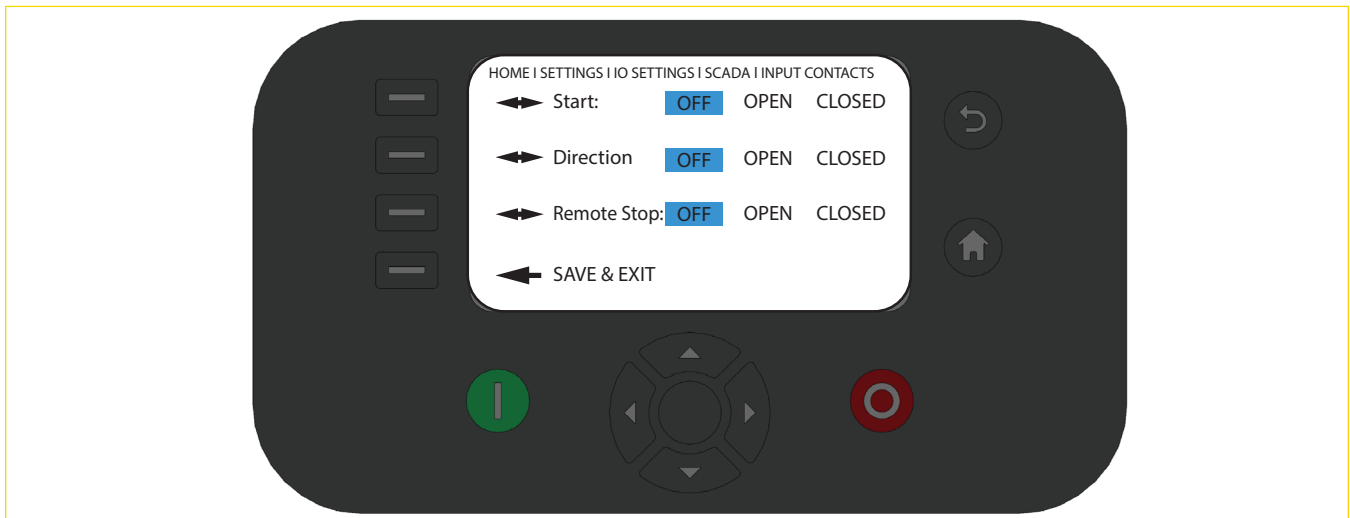



# KML - SERIES

## Operating Modes

### Four Configurable Relay outputs:

- » Disabled
- » General Alarm
- » In Auto
- » Door Open
- » Leak Detected
- » Pump Off
- » Remote Stop Alarm
- » Remotely Controlled

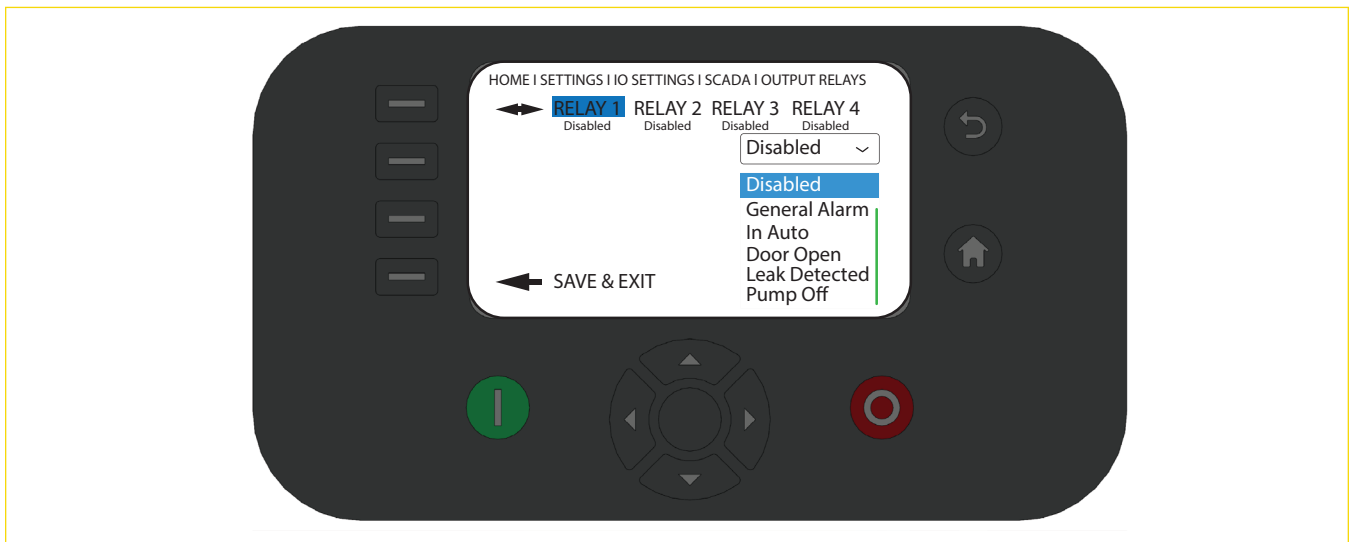

### 6.2.2 | INDUSTRIAL PROTOCOLS

Select Industrial Protocols from I/O Settings Screen shown in 5.5.4

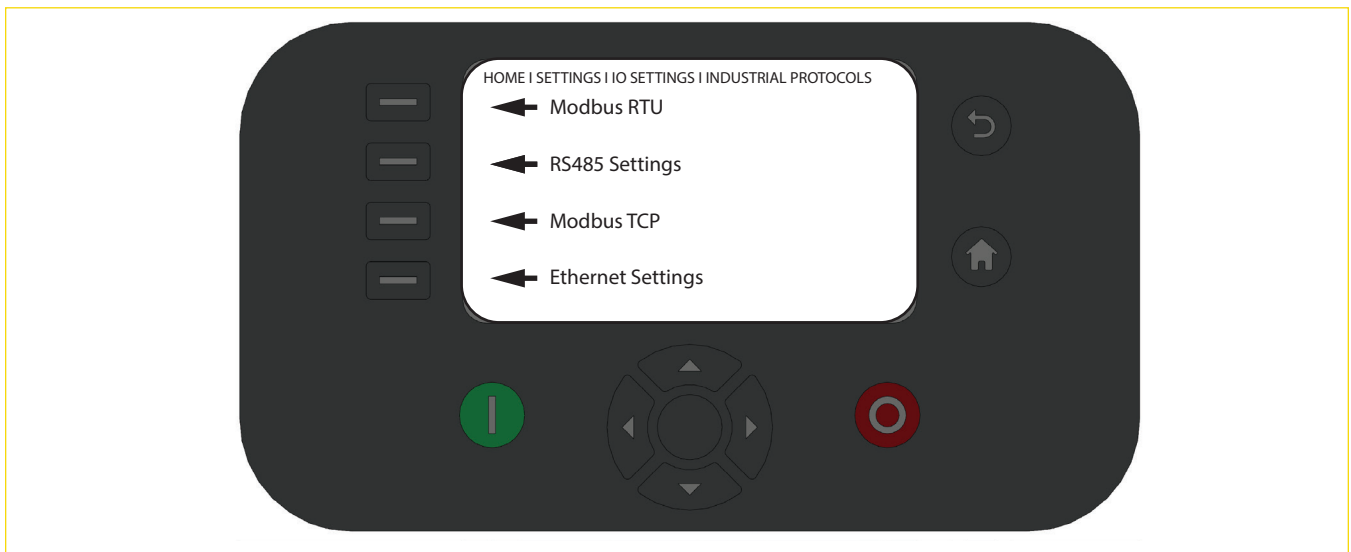



# LMI<sup>®</sup> KML - SERIES

## Operating Modes

### 6.2.2.1 | MODBUS RTU

Configure device address to connect MODBUS RTU"

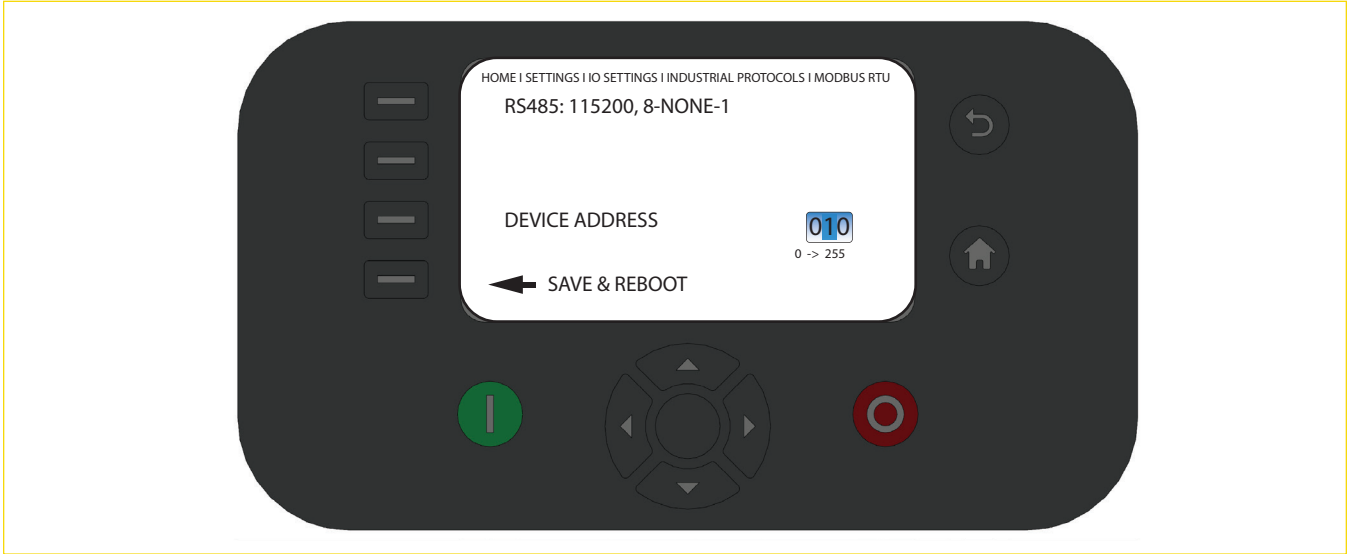

### 6.2.2.2 | MODBUS TCP

Configure TCP port to connect MODBUS TCP

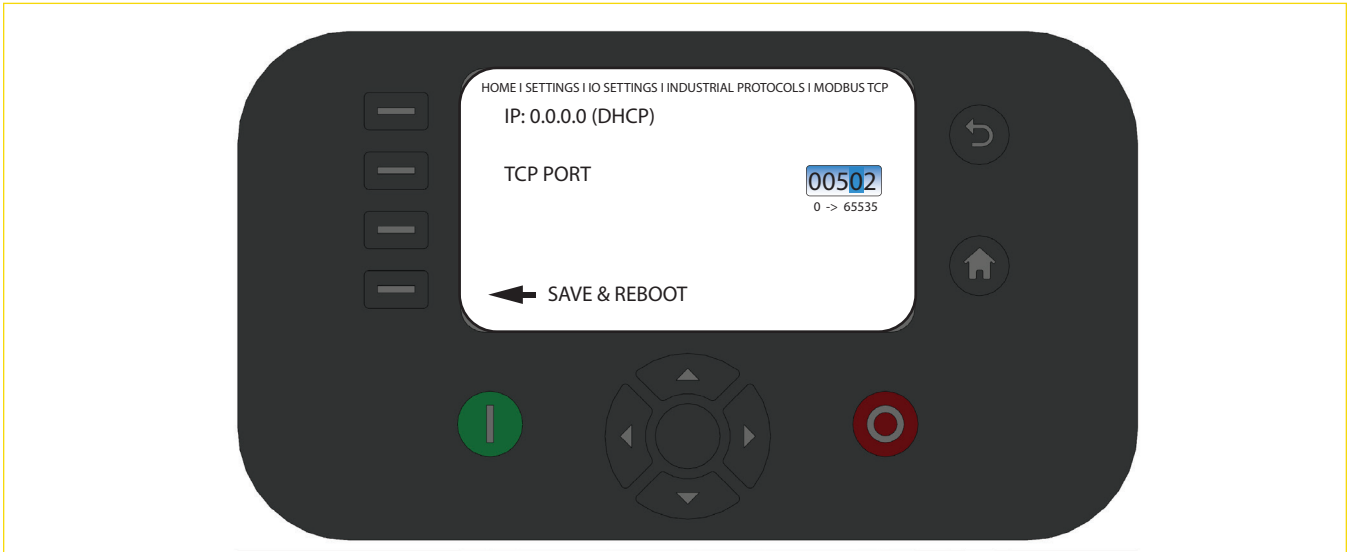



# KML - SERIES

## Operating Modes

### 6.2.2.3 | RS 485

Configure RS485 BAUD, Parity and Stop parameters

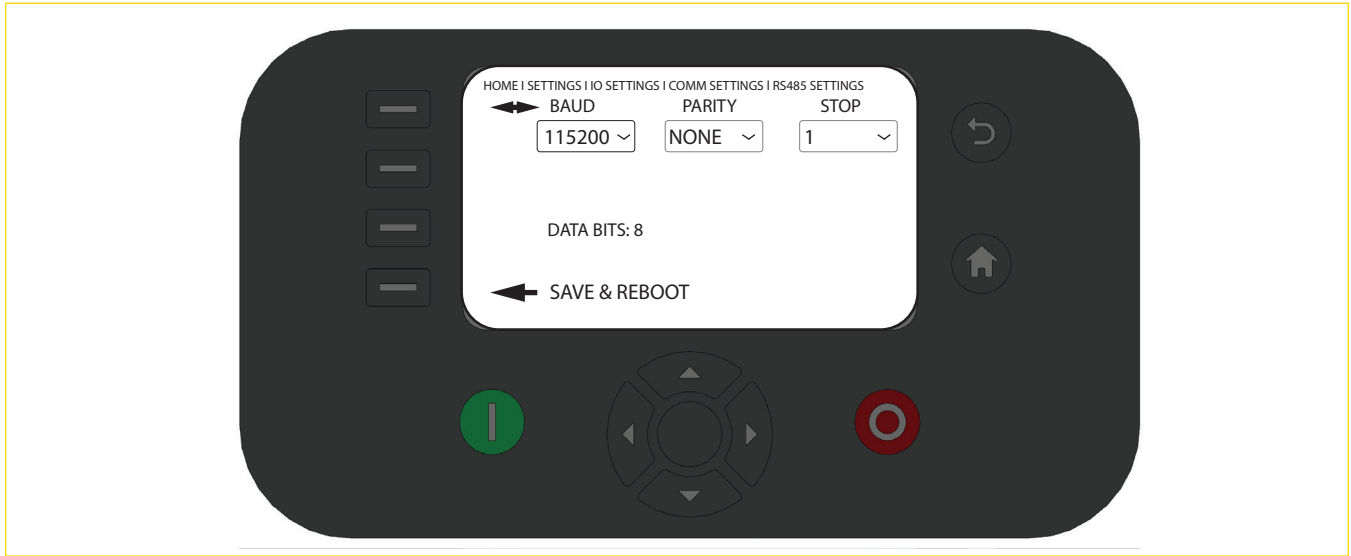

### 6.2.3 | BATCH / DOSE MODE

Navigate to dose settings by selecting the pump speed icon on the home screen.

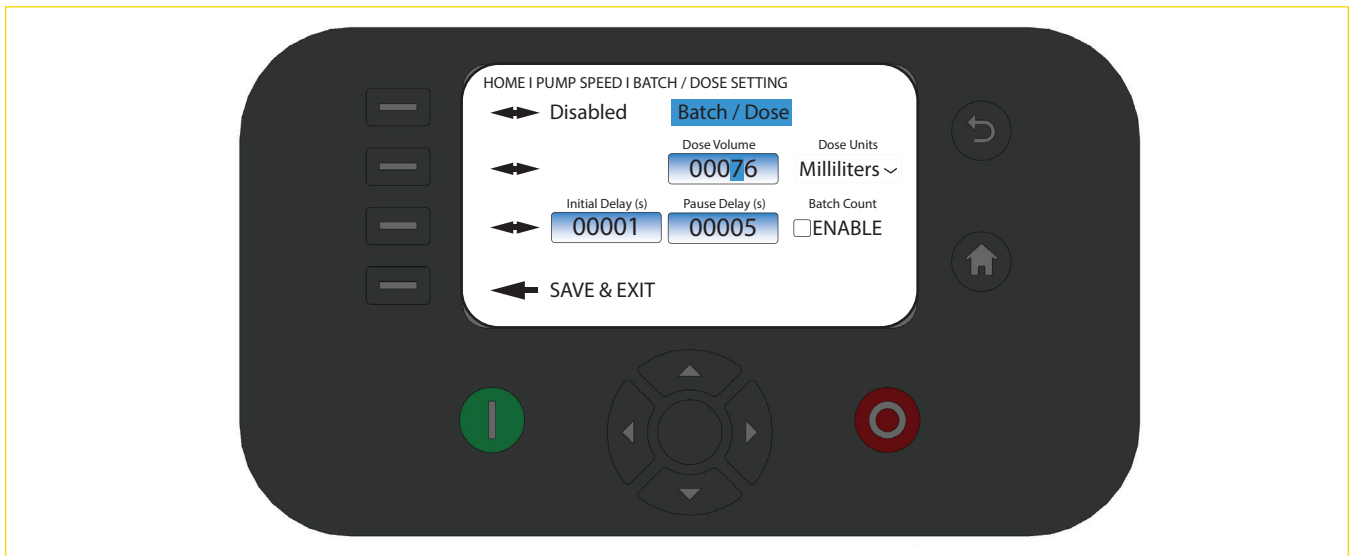

### 6.2.3.1 | DOSING

Fixed number of multiple doses with a programmable start delay and intra-dose time interval.

Batch size can be user specified & pump counts down until completion.

# LMI® KML - SERIES

## Operating Modes

### 6.2.3.2 | BATCHING

In Dose mode, the doses will continue until the pump is manually stopped.

Minimum dose size will be limited to the volume of one revolution of the rotor. This is automatically calculated by the factory or calibrated values.

Dose speed will default to the manual set speed speed. However, for small doses, the pump will automatically slow down the pump if required to maintain accuracy.

#### Display in Batch Mode

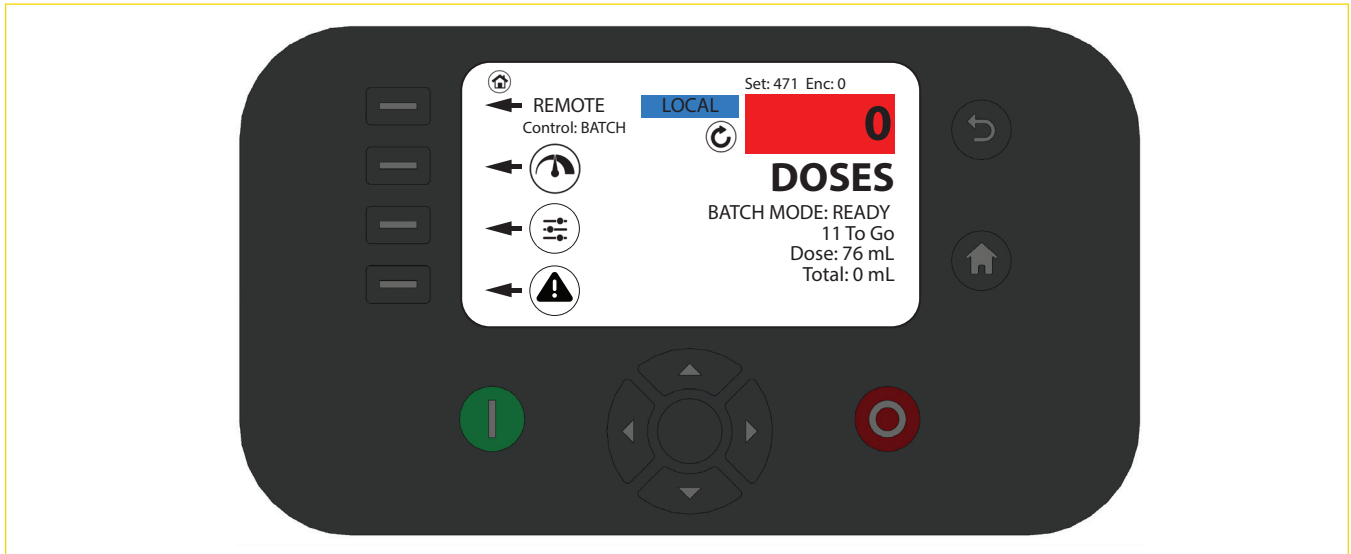

#### Display in Dose Mode

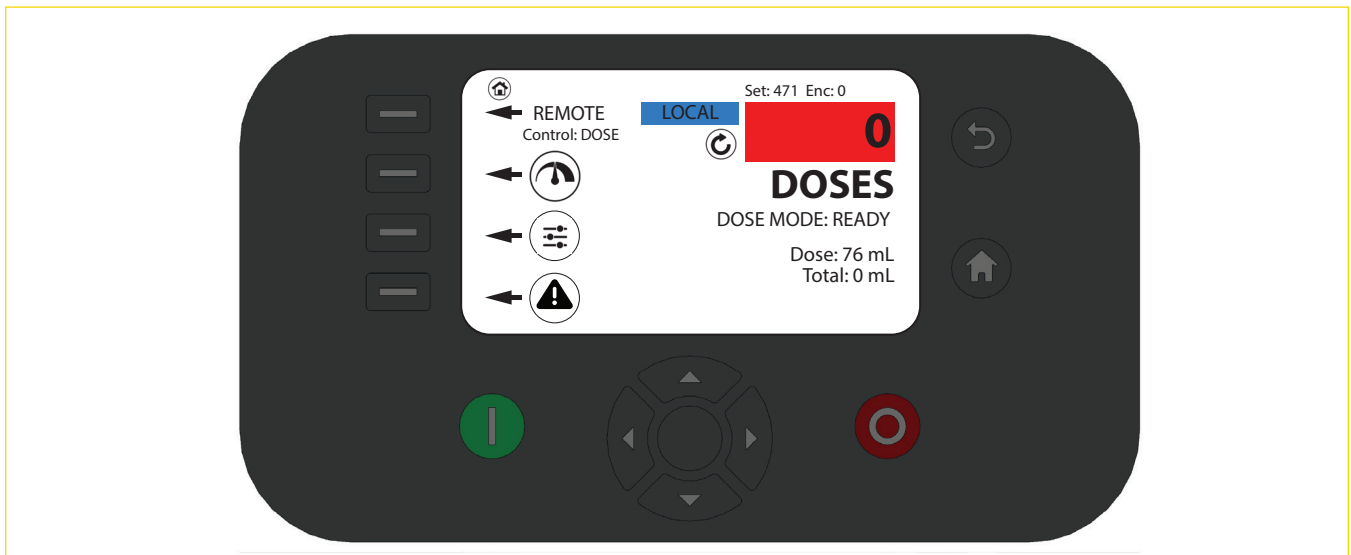

# LMI<sup>®</sup> KML - SERIES Maintenance

## 7.1 | ROUTINE INSPECTION

Pump and accessories should be inspected weekly.

Inspect all components for signs of leaking or chemical attack.

Replace damaged or worn components immediately.

Cracking, crazing, discoloration and the like during first week of operation are signs of chemical attack.

Inspect check valve and pressure relief valves periodically to ensure performance.

KML pump motor and gearbox does not require maintenance.

Inspect optical sensor for obstructions or fluid

## 7.2 | TUBE REPLACEMENT

- » Isolate pump from the system, depressurize and drain suction and discharge lines.
- » In Maintenance Mode, jog the pump to index the rotor assembly such that the red button is between the tube connections.
- » Remove the front cover taking proper precautions:
  - \* If the tube has failed, chemical or residue may be present in the pumphead and/or tube.
  - \* If the tube has not failed, product is contained within the tube and will drain as the tube is removed.
- » Press the red button on the rotor to disengage the rotor assembly from the tube.

 **LMI**<sup>®</sup> **KML - SERIES**  
Maintenance



- » Remove the tube.
- » Inspect the pump head chamber, rotor assembly, and pump head cover. Wipe away any dirt and debris.
- » Install the new tube. Ensure the tube fittings are properly aligned and secure within the pumphead.
- » Jog pump to reengage rotor assembly.
- » Replace front cover.
- » Connect suction and discharge lines and open valves as appropriate.

# LMI<sup>®</sup> KML - SERIES Maintenance

## 7.3 | ROTOR ASSEMBLY REPLACEMENT

- » Remove the tube assembly according to O&M Instructions.
- » The rotor assembly can be removed by hand.
- » Inspect and wipe down the pump head and shaft.
- » Inspect and wipe down the optical sensor
- » Install the new rotor assembly with new spacers as shown.



# LMI<sup>®</sup> KML - SERIES Maintenance

## 7.4 | SPARE PARTS

Contact your distributor or [www.lmipumps.com](http://www.lmipumps.com) for ordering information, or access LMI Service Point via the QR code on your pump.





# LMI<sup>®</sup> KML - SERIES

## Maintenance



### KML2 SPARE PARTS

Item	Description	Max Flow		Max Pressure		Part Number
		gph	L/h	psi	bar	
1	Rotor Assembly for AD1 tubes, includes spacer bushings					K2-R-A
2	Tube Assembly, 1/2" NPT/BSPT and 3/8" tube compression, XL, 0.075" ID	1.7	6.5	125	8.6	K2-AAD1
1	Rotor Assembly for BH1 tubes, includes spacer bushings					K2-R-B
2	Tube Assembly, 1/2" NPT/BSPT and 3/8" tube compression, CR, 0.25" ID	14.2	54	50	3.4	K2-ABH1
1	Rotor Assembly for CG1 and CG2 tubes, includes spacer bushings					K2-R-C
2	Tube Assembly, 1/2" NPT/BSPT and 3/8" tube compression, PT, 0.187" ID	9.3	35.2	65	4.5	K2-ACG1
2	Tube Assembly, 1/2" NPT/BSPT and 3/8" tube compression, PT, 0.187 ID twin	14.9	56.7	65	4.5	K2-ACG2
1	Rotor Assembly for AE2 and AG2 tubes, includes spacer bushings					K2-R-D
2	Tube Assembly, 1/2" NPT/BSPT and 3/8" tube compression, XL, 0.125 ID twin	4.4	16.8	110	7.6	K2-AAE2
2	Tube Assembly, 1/2" NPT/BSPT and 3/8" tube compression, XL, 0.187 ID twin	17.1	65.1	110	7.6	K2-AAG2
3	Pump Head Cover with Bearing and Thumbscrews					K2-COVER
not shown	mounting bracket with fasteners					K2-STDB
not shown	extended mounting bracket with fasteners					K2-EXTB
not shown	rubber feet					K2-FEET
not shown	installation kit: suction and discharge tubing with foot valve and check valve					K2-INSKIT



**LMI**<sup>®</sup>

# KML - SERIES

## Maintenance



### KML3 SPARE PARTS

Item	Description	Max Flow		Max Pressure		Part Number
		gph	L/h	psi	bar	
1	Rotor Assembly for AD1 tubes, includes spacer bushings					K3-R-A
2	Tube Assembly, 1/2" NPT/BSPT and 3/8" tube compression, XL, 0.075" ID	2.1	7.9	125	8.6	K3-AAD1
1	Rotor Assembly for KL tubes, includes spacer bushings					K3-R-B
2	Tube Assembly, 1/2" NPT/BSPT and 3/8" tube compression, XL, 0.375" ID	33.2	126	30	2.1	K3-AAKL
1	Rotor Assembly for CG1, CG2, and CK1 tubes, includes spacer bushings					K3-R-C
2	Tube Assembly, 1/2" NPT/BSPT and 3/8" tube compression, PT, 0.187" ID	10.1	28.4	65	4.5	K3-ACG1
2	Tube Assembly, 1/2" NPT/BSPT and 3/8" tube compression, PT, 0.187" ID twin	18.2	69	65	4.5	K3-ACG2
2	Tube Assembly, 1/2" NPT/BSPT and 3/8" tube compression, PT, 0.375" ID	28.4	108	65	4.5	K3-ACK1
1	Rotor Assembly for AE2, AG2, AK1, and BK1 tubes, includes spacer bushings					K3-R-D
2	Tube Assembly, 1/2" NPT/BSPT and 3/8" tube compression, XL, 0.125" ID twin	4.7	18	125	8.6	K3-AAE2
2	Tube Assembly, 1/2" NPT/BSPT and 3/8" tube compression, XL, 0.187" ID twin	18.9	72	110	7.6	K3-AAG2
2	Tube Assembly, 1/2" NPT/BSPT and 3/8" tube compression, XL, 0.375" ID	33.2	126	125	8.6	K3-AAK1
2	Tube Assembly, 1/2" NPT/BSPT and 3/8" tube compression, CR, 0.375" ID	28.4	108	50	3.4	K3-ABK1
3	Pump Head Cover with Bearing and Thumbscrews					K3-COVER
not shown	mounting bracket with fasteners					K3-STDB
not shown	extended mounting bracket with fasteners					K3-EXTB
not shown	rubber feet					K3-FEET
not shown	installation kit: suction and discharge tubing with foot valve and check valve					K3-INSKIT



### KML4 SPARE PARTS

Item	Description	Max Flow		Max Pressure		Part Number
		gph	L/h	psi	bar	
1	Rotor Assembly for AH1 and AH2 tubes, includes spacer bushings					K4-R-A
2	Tube Assembly, 1/2" NPT/BSPT, XL, 0.25" ID	28.4	108	125	8.6	K4-AAH1
2	Tube Assembly, 1/2" NPT/BSPT, XL, 0.25" ID twin	53.7	204	100	6.9	K4-AAH2
1	Rotor Assembly for BK1 and BK2 tubes, includes spacer bushings					K4-R-B
2	Tube Assembly, 1/2" NPT/BSPT, CR, 0.375" ID	53.7	204	30	2.1	K4-ABK1
2	Tube Assembly, 1/2" NPT/BSPT, CR, 0.375" ID twin	125.5	477	30	2.1	K4-ABK2
1	Rotor Assembly for CH1, CK1, and CK2 tubes, includes spacer bushings					K4-R-C
2	Tube Assembly, 1/2" NPT/BSPT, PT, 0.25" ID	39.5	150	65	4.5	K4-ACH1
2	Tube Assembly, 1/2" NPT/BSPT, PT, 0.375" ID	55.3	210	65	4.5	K4-ACK1
2	Tube Assembly, 1/2" NPT/BSPT, PT, 0.375" ID twin	99.5	378	65	4.5	K4-ACK2
1	Rotor Assembly for AL1 and AP1 tubes, includes spacer bushings					K4-R-D
2	Tube Assembly, 1/2" NPT/BSPT, XL, 0.5" ID	99.5	378	50	3.4	K4-AAL1
2	Tube Assembly, 1/2" NPT/BSPT, XL, 0.75" ID	157.9	600	30	2.1	K4-AAP1
3	Pump Head Cover with Bearing and Thumbscrews					K4-COVER
not shown	mounting bracket with fasteners					K4-STDB
not shown	extended mounting bracket with fasteners					K4-EXTB
not shown	rubber feet					K4-FEET



# KML - SERIES

## Troubleshooting

### 8.1 | TROUBLESHOOTING GUIDE

PROBLEM	POSSIBLE REASON	RESOLUTION
Low Flow Low Discharge Pressure	Viscosity too high.	Run pump slower to allow more time for tube to restate.
		Select larger tube and run slower.
		Improve suction pressure.
	Poor suction conditions.	Run pump slower to allow more time for tube to restate.
		Ensure fittings and connections are tight so that no air may enter suction line.
		Clean suction strainer (if used).
		Increase tank level and/or tank height.
		Apply best hydraulic practices - use large pipework, minimize pipe length, reduce obstructions, and use a suction accumulator.
		Check suction line for obstructions.
	Tube dimensions do not match the specifications of the rotor assembly.	Install matched roller assembly and tube.
	Discharge pressure too high, causing excessive backflow.	Reduce discharge pressure.
		Decrease friction losses in discharge pipework.
	Using third-party tubing.	Use only LMI tube assemblies.
	Tube obstruction.	Check tube for obstructions.
	Pump not properly calibrated.	Perform calibration under application conditions per O&M.



# KML - SERIES

## Troubleshooting

### 8.1 | TROUBLESHOOTING GUIDE

PROBLEM	POSSIBLE REASON	RESOLUTION	
Tube Fails Prematurely.	Tube not installed correctly.	Check installation of tube.	
	Fluid temperature too high.	Reduce fluid temperature.	
	Mechanical damage to tube from solids.	Use suction strainer to prevent solids from entering pump.	
	Possible chemical attack.	Check compatibility of tube material with product being pumped.	
	Operating pressure too high.	Reduce discharge pressure.	
	Tube dimensions do not match the specifications of the rotor assembly.	Install matched roller assembly and tube.	
Excessive Noise and/or Vibration.	Tube dimensions do not match the specifications of the rotor assembly.	Install matched roller assembly and tube.	
	Loose fittings and/or pipework.	Ensure fittings are tight and pipework is properly secured and supported.	
	Pulsation - wide swing in discharge pressure during operation.	Apply best hydraulic practices - use large pipework, minimize pipe length, reduce obstructions, and use a pulsation dampener.	
Tube Leak Not Detected.	Optical sensor is dirty.	Clean contamination from the surface of the optical sensor.	
High Pump Temperature	Rotor assembly is worn.	Check that all rollers are free to spin and that there is no interference or binding of the rotor assembly within the pumphead or front cover.	
	Fluid temperature too high.	Reduce fluid temperature.	
	High discharge pressure or poor suction conditions.	Reduce discharge pressure and/or improve suction conditions.	
	Ambient temperature too high.	Operate within recommended limits.	
		Locate pump out of direct sunlight.	
Locate pump away from other equipment which may be hot.			



**LMI**<sup>®</sup> **KML - SERIES**  
Troubleshooting



**8.2 | ERROR CODES**



# KML - SERIES

Agency & Compliance

## 9.1 | CERTIFICATES





# KML - SERIES

## Warranty Declaration.

### 10.1 | FLUSH & DECONTAMINATION

Any returns of pumps or parts for repair or warranty inspection must be pre-approved by customer service. Also, the Flush and Decontamination document on the following pages must be completed and submitted to customer service for approval.

## RETURN MATERIAL INFORMATION

### PAGE 1 OF 2

Select location where Flush & Decon was performed:

Sold To

Ship To

Company: \_\_\_\_\_  
 Address: \_\_\_\_\_  
 \_\_\_\_\_  
 Performed By: \_\_\_\_\_  
 Email: \_\_\_\_\_  
 Phone: \_\_\_\_\_

Company: \_\_\_\_\_  
 Address: \_\_\_\_\_  
 \_\_\_\_\_  
 Performed By: \_\_\_\_\_  
 Email: \_\_\_\_\_  
 Phone: \_\_\_\_\_

Pump Model / Part #: \_\_\_\_\_

Quantity: \_\_\_\_\_

Serial #: \_\_\_\_\_

**RETURN SHIP TO: If this section is not completed, return defaults to ship to address on original order.**  
 Company Name: \_\_\_\_\_  
 Attn: \_\_\_\_\_ Phone: \_\_\_\_\_  
 City: \_\_\_\_\_ State: \_\_\_\_\_ Zip Code: \_\_\_\_\_

### PRE- APPROVAL REQUIRED PROCESS:

**Flush & Decon must be submitted PRIOR to receiving RMA # with return shipping instructions.**  
 Failure to provide completed form will result in the quarantine of equipment along with **CHARGE BACK FEE** applied for handling and disposal of unknown material (see page 2).

### INSTRUCTIONS:

### INITIAL EA.

1. **Triple FLUSH** & decontaminate liquid end or wetted part. (see page 2)  
**In case of failure to decontaminate, delivery of shipment will be refused and returned with freight charge billed to customer.** \_\_\_\_\_
2. For pumps, remove **BOTH** check valves from head, FLUSH checks & head.  
 Reinstall checks or **RETURN CHECKS WITH PUMP** properly packaged separately to eliminate damage. \_\_\_\_\_
3. **DRAIN "ALL"** oil from pump \_\_\_\_\_
4. **INCLUDE SDS** covering all chemical handled by the pump. \_\_\_\_\_
5. Make sure **INTERIOR (Liquid end & drive)** of pump is cleaned of any chemical \_\_\_\_\_
6. Thoroughly **CLEAN exterior** of pump to remove dirt. \_\_\_\_\_
7. **Parts:** Remove entire accessory component from piping along with any welded piping attached to accessory union or flange. \_\_\_\_\_
8. When RMA# is provided, make sure RMA # is prominently shown on BOL \_\_\_\_\_



# KML - SERIES

## Warranty Declaration.

### FLUSHING & DECONTAMINATION CERTIFICATION

#### PAGE 2 OF 2

Process Liquid: \_\_\_\_\_

Decontamination Liquid: \_\_\_\_\_

Flushing Liquid: \_\_\_\_\_

- All equipment returned must be completely drained, flushed & decontaminated of all process fluids internally & externally.
- Completed form along with SDS must be submitted PRIOR to receiving RMA # & return shipping instructions.
- Failure to provide completed 2-page forms will result in quarantine of equipment along with CHARGE BACK FEE applied for handling unknown material.
- RMA # should be visible on return BOL.

I certify this equipment has been drained, flushed, decontaminated and check valves are sent along with the pump in accordance with Milton Roy Company's procedures. All information contained herein is accurate.

Name (Print): \_\_\_\_\_

Title: \_\_\_\_\_

Signed: \_\_\_\_\_

Date: \_\_\_\_\_

Return Address: Milton Roy Americas  
201 Ivyland Road  
Ivyland, PA 18974  
USA

**CHARGE BACK FEE** – handling unknown material:

PARTS..... \$1,500.00  
PUMPS..... \$2,000.00

**\*\*\*IMPORTANT\*\*\*** Please return pump base if suction check valve is lower than the bottom of the pump. This is needed to test and ship unit.

**INTERNAL USE ONLY**

To be completed by Milton Roy internal EHS.

RMA#: \_\_\_\_\_ Approved for return: Yes \_\_\_ No \_\_\_ Approval Date: \_\_\_\_\_

Received Date: \_\_\_\_\_



## About Ingersoll Rand Inc.

Ingersoll Rand Inc. (NYSE:IR), driven by an entrepreneurial spirit and ownership mindset, is dedicated to helping make life better for our employees, customers and communities. Customers lean on us for our technology-driven excellence in mission-critical flow creation and industrial solutions across 40+ respected brands where our products and services excel in the most complex and harsh conditions. Our employees develop customers for life through their daily commitment to expertise, productivity and efficiency. For more information, visit [www.IRco.com](http://www.IRco.com).

We are committed to using environmentally conscious print practices

©2023 Ingersoll Rand  
LMI-0823-004-EN